



VIC Leak Detection

Vacuum Metrology

MS-50 AUTOMATIC LEAK DETECTOR SYSTEM MANUAL



Vacuum Instrument Corporation Vacuum Metrology Division
2099 Ninth Avenue, Ronkonkoma, New York 11779
Tel. 631.737.0900 Fax. 631.737.1541
E-Mail: vicsales@vacuuminst.com
WebSite: www.vacuuminst.com

CHAPTER ONE: General Overview **1**

Section	Page
1.0 Introduction	1-1
1.1 General Information	1-2
1.2 Installation	1-3
1.3 MS-50 Accessory Kit	1-5
1.4 MS-50 Features	1-5
1.5 MS-50 Performance Specifications	1-7
1.6 Electronics & User Interface	1-9
1.7 Power Requirements	1-10
1.8 Dimensions & Weight	1-10
1.9 MS-50 General Description	1-11

CHAPTER TWO: Theory of Operation **2**

2.0	Introduction to Leak Detection Theory and Methods	2-1
2.1	Functional Description of MS-50 Leak Detector Operation	2-4
	2.1.1 The MS-50 Test Cycle	2-4
	2.1.2 Power Failure Protection	2-8
2.2	Leak Testing Flow Modes	2-9
	2.2.1 Reverse Flow Mode	2-9
	2.2.2 Direct Flow Mode	2-9
	2.2.3 Gross Leak Testing	2-10
2.3	Description of Major Components	2-14
	2.3.1 Vacuum System	2-14
	<i>Mass Spectrometer</i>	2-14
	<i>Source</i>	2-14
	<i>Magnetic Deflector Assembly</i>	2-14
	<i>Ion Collector</i>	2-15
	2.3.2 Valve Block Assembly	2-15
	<i>Calibrator Valve</i>	2-16
	<i>Direct Valve</i>	2-16

	<i>Foreline Valve</i>	2-16
	<i>Reverse Valve</i>	2-16
	<i>Gross Valve</i>	2-16
	<i>Sniffer Valve</i>	2-16
	<i>Vent Valve</i>	2-16
	<i>Vent Line Connection</i>	2-16
	<i>Test Port</i>	2-17
	<i>Test Port Pirani</i>	2-16
	<i>Foreline Pirani</i>	2-17
	<i>Rough Valve</i>	2-17
2.3.3	Pumps	2-17
	<i>Roughing Pump</i>	2-17
	<i>Foreline Pump</i>	2-17
	<i>High-Vacuum Turbo Pump</i>	2-17
2.3.4	Calibrator	2-17

CHAPTER THREE: Operating the MS50

3

3.0	Introduction	3-1
3.1	MS-50 Main Controls and Connections	3-2
3.1.1	Front Panel Controls	3-2
	<i>Power I/O Switch</i>	3-2
	<i>Key-switch</i>	3-2
	<i>Audio Speaker/Headphone Jack</i>	3-2
3.1.2	Rear Panel Connections	3-2
	<i>Printer</i>	3-2
	<i>Monitor Power</i>	3-4
	<i>RS-232 Port (1)</i>	3-4
	<i>RS-232 Port (2)</i>	3-4
	<i>AC Power Connector</i>	3-4
	<i>Chart</i>	3-4
	<i>Nitrogen</i>	3-4
	<i>Exhaust</i>	3-4

3.1.3	The User Panel	3-4
3.1.3-1	Service Mode Controls	3-4
	<i>Valves</i>	3-6
	<i>Amp Gains</i>	3-6
	<i>Turbo</i>	3-6
3.1.3-2	Operator Controls (Normal/Set Mode)	3-7
	<i>System:</i>	3-7
	Cal Check	3-7
	Tune	3-7
	<i>Zero</i>	3-7
	<i>Scan</i>	3-8
	<i>Mass Spec:</i>	3-8
	Fil On/Off	3-8
	Fil 1/2	3-8
	<i>Audio</i>	3-8
	<i>Modes:</i>	3-9
	Sleep	3-9
	Vac/Sniff	3-9
	<i>Ranging</i>	3-9
3.1.4	Soft-keys	3-10
3.1.5	The Start/Vent Panel	3-10
	<i>Start</i>	3-10
	<i>Vent</i>	3-10
3.1.6	The CRT Display Monitor	3-10
3.2	Leak Detector Operation: Overview	3-11
3.2.1	Powering Up the Leak Detector	3-11
3.2.2	Ready To Test (Standby) Mode: CRT Display	3-12
3.2.3	Vacuum Leak Testing Modes and Procedures	3-13
	<i>About Vacuum Testing</i>	3-13
	<i>Vacuum Testing: Automatic Flow Mode</i>	
	<i>Switching/Auto Ranging/Gross Screening On</i>	3-13

	Vacuum Testing: <i>Automatic Flow Mode Switching/Manual Ranging</i>	3-15
	Vacuum Testing: <i>Automatic Flow Mode Switching/Gross Screening Off</i>	3-16
	Vacuum Testing: <i>MS-50 Locked into Direct Flow Mode/Gross Screening On</i>	3-17
	Vacuum Testing: <i>MS-50 Locked into Direct Flow Mode/Gross Screening Off</i>	3-18
	Vacuum Testing: <i>MS-50 Locked into Reverse Flow Mode/Gross Screening On</i>	3-19
	Vacuum Testing: <i>MS-50 Locked into Reverse Flow Mode/Gross Screening Off</i>	3-20
3.2.4	Sniff Testing	3-21
3.3	MS-50 Tuning and Calibration	3-23
3.3.1	Auto Tune and Calibration	3-23
3.3.1.1	Auto Tune Alert	3-24
3.3.1.2	Automatic Auto Tune	3-25
3.3.2	Cal Check	3-26
3.3.3	Calibration Procedure for Helium 3	3-27
3.3.4	Using the Scan Function	3-28
3.3.5	Gross Mode Calibration	3-28
3.4	Setting Test Parameters	3-29
3.4.1	The Help/Settings Menu	3-29
3.4.2	Storing Test Recipes	3-30
3.4.3	Reject Point	3-30
3.4.4	Reverse Crossover	3-31
3.4.5	Direct Crossover	3-32
3.4.6	Minimum Rough Time	3-33
3.4.7	Minimum Gross Time	3-33
3.4.8	Delay Settings (Valve Timing Settings)	3-35
3.4.9	Reverse Rough Close	3-35
3.4.10	Direct Rough Close	3-36
3.4.11	Direct Crossover Delay	3-36
3.4.12	Vent Open Delay	3-37

3.4.13	Internal Calibrator	3-37
3.4.14	External Calibrator	3-37
3.4.15	Reject Display	3-38
3.4.16	Gross Screening	3-38
3.4.17	Flow Modes	3-39
3.4.18	Vent Duration	3-39
3.4.19	Pressure Units	3-40
3.4.20	Leak Units	3-40
3.4.21	Gas Type	3-40
3.4.22	Helium Type	3-40
3.4.23	Test Port Display	3-41
3.4.24	Internal Calibrator Temperature	3-41
3.4.25	Selected Calibrator	3-42
3.5	The Help/System Menu	3-43
3.5.1	Help Menu	3-43
3.5.2	Time and Date Menu	3-43
3.5.2.1	Set Time of Day/Calendar Date	3-43
3.5.3	Languages	3-45

CHAPTER FOUR: Service & Maintenance

4

4.0	Introduction	4-1
4.1	Service Mode	4-1
4.2	Periodic Maintenance	4-4
4.2.1	Grease Test Port O-Ring	4-4
4.2.2	Checking Air Filters	4-5
4.2.3	Checking Exhaust Filter Cartridge in Rotary Vane Mechanical Pumps	4-5
4.2.4	Checking Oil Level in Rotary Vane Mechanical Pumps	4-5
4.2.5	Changing the Oil in Rotary Vane Mechanical Pumps	4-7
4.2.6	Replacing the Turbo Pump Operating Fluid Reservoir Cartridge	4-8
4.2.7	Re-calibrating the Internal Leak Standard (Calibrator)	4-8

4.3	Vacuum System Contamination	4-10
4.3.1	Indications of Contamination	4-10
4.3.2	Sensitivity Check	4-11
4.3.3	Foreline Pump Oil Contamination	4-11
	Opening the Gas Ballast	4-12
4.3.4	Venting the Vacuum System	4-13
4.3.5	Vacuum System Cleaning Requirements	4-14
4.3.6	Cleaning Procedure for Contaminated Parts	4-14
4.3.7	Cleaning the Mass Spectrometer	4-16
	Mass Spectrometer Assembly Diagram	4-18
4.3.8	Replacing the Filaments	4-20
	Replacing the Filaments Diagram	4-21
	Aligning the Filament	4-22
4.3.9	Valve Cleaning	4-23
4.3.10	Servicing the Direct, Reverse, and Vent Valves	4-23
	Valve Block Components Diagram	4-24
4.3.11	Servicing the Gross Valve	4-26
4.3.12	Servicing the Sniff Valve	4-28
4.3.13	Servicing the Rough Valve	4-29
	Rough Valve Diagram	4-30
4.3.15	Cleaning the Turbo Pump	4-32
4.4	Components Requiring Calibration	4-33
4.4.1	Test Port Pirani Calibration	4-33
4.4.2	Foreline Pirani Calibration	4-34
4.4.3	High Vacuum Gauge Calibration	4-35
4.4.4	Calibrating the Temperature Sensor	4-36
4.5	Circuit Boards	4-36
4.6	Servicing the MS-50 Monitor (CRT)	4-37
4.7	MS-50 Error Messages	4-37

APPENDICES

A - G

Appendix A: MS-50 Parts List

Appendix B: Glossary

Appendix C: Conversion Tables

Appendix D: A.V.S Standards

Appendix E: MS-50 Quick Reference

Appendix F: Remote Port Specifications

Appendix G: MS-50 Dual Port Unit

1.0 Introduction

This manual explains in detail the operation and functions of the Vacuum Instrument Corporation MS-50 Automatic Leak Detector, and provides the necessary information to properly service and maintain the unit.

The manual has been organized into four major sections:

- Chapter 1: General Information**
- Chapter 2: Theory of Operation**
- Chapter 3: Operating the MS50**
- Chapter 4: Service & Maintenance**

Chapter 1, General Information, provides information on unpacking, inspection, and installation of the MS-50, and outlines unit features, accessories, and performance specifications.

Chapter 2, Theory of Operation, contains a functional description of leak detector operation and reviews the major components of the MS-50 system.

Chapter 3, Operating the MS-50, explains the MS-50 User Panel controls and screen-based user interface. External connections and their functions are discussed. The unit's start-up sequence and various leak test modes are explained in step-by-step fashion. System tuning and calibration procedures and the customizing of test parameters are also covered.

Chapter 4, Service & Maintenance, describes in detail the MS-50 Service mode, including: Periodic service requirements and maintenance routines, detection and elimination of vacuum system contaminants, vacuum system venting, and valve block service and repair. A troubleshooting chart lists all MS-50 error codes, their probable causes, and recommended corrective actions.

The **Appendices** at the end of the manual provide additional information about the MS-50 and vacuum leak testing in general, including: recommended spare parts, a glossary, leak rate conversion tables, an A.V.S. reference, RS-232 remote communication port specifications, and MS-50 operator quick reference charts.

The MS-50 is a highly technical system that incorporates many sophisticated technologies. In view of this, every effort has been made to automate the unit's operation and maintenance procedures. It is imperative, however, that users and service personnel familiarize themselves with the operation and maintenance procedures in this manual in order to maximize the effectiveness of the unit.

1.1 General Information

1.1.2 Unpacking & Inspection

The MS-50 is shipped in a specially constructed carton that minimizes the possibility of damage during transit. The shipping carton and packing materials should be saved for future use. A **Bill of Materials** is packed within the carton indicating all of the items shipped with the unit.

Prior to unpacking the MS-50, inspect the exterior carton for any signs of damage. After unpacking, inspect the leak detector itself for any obvious damage. If the unit is damaged, a claim should be filed immediately with the shipping carrier; a copy of that claim *must* also be forwarded to Vacuum Instrument. Should the MS-50 fail to function as required, or fail to meet its specifications, contact the Customer Service Department at Vacuum Instrument Corporation (**Vacuum Instrument Corporation, 2099 Ninth Avenue, Ronkonkoma, NY 11779; tel: (631) 737 - 0900; fax: (631) 737-1541**) or your local customer representative. It is required that Vacuum Instrument be contacted prior to the return of any damaged equipment.

Once the leak detector has been removed from its package, the MS-50 must be opened and all shipping material removed from the unit's rotary vane mechanical pumps. To access the pumps, remove the left side access panel (the panel can be easily popped off by pulling along its beveled bottom edge). After all shipping material has been removed, replace the panel.

NOTE:

Both rotary vane pumps are filled with oil prior to shipment. Nevertheless, the oil level in these pumps should be checked as a precaution before the unit is turned on.

1.2 Installation

The MS-50 leak detector has been factory tested and calibrated prior to shipment and, once installed, is ready for use.

Before installation in the work area, certain requirements must be met:

- A properly grounded electrical supply must be available for the unit (*see section 1.7*).
- A user-provided helium supply is necessary for leak testing. The MS-50 can use either a Mass 4 or Mass 3 helium supply. Virtually any standard purity helium may be used. Depending on the type of leak testing performed, a spray probe (for vacuum testing), a sniffer assembly (for sniff testing) or a test cup (for pressure bombing testing) will be necessary. All of these items are available directly from Vacuum Instrument Corp.
- The recommended ambient temperature range for the unit is **10°C / 50° F** to **40°C / 104° F**. Also, excessively humid environments should be avoided.
- Connecting the MS-50 to an external exhaust facility is recommended. A bulkhead fitting is installed on the rear of the MS-50 that is intended for user-provided 1/2" OD plastic tubing. The tubing can then be attached to an exhaust system.
- The MS-50 should be connected to a dry nitrogen supply. Dry nitrogen is used to purge the vacuum system and pumps of residual helium and contaminants. A bulkhead fitting, for use with 3/8" O.D. plastic tubing (user-provided) is provided on the rear of the unit for this purpose.

A section of flexible polyflow tubing (with sintered metal filter) is used to connect the nitrogen bulkhead’s interior fitting to the MS-50 vacuum system and pumps. This tube is not attached to the bulkhead in the factory; the user must connect it before nitrogen purging may be undertaken

(NOTE: The section of tubing that runs to the forepump is connected in the factory prior to shipping).

Figure 1-1

Left:

Connecting the N2 bulkhead to the vacuum system.

Right:

MS-50 Assembly detail showing connected tubing.

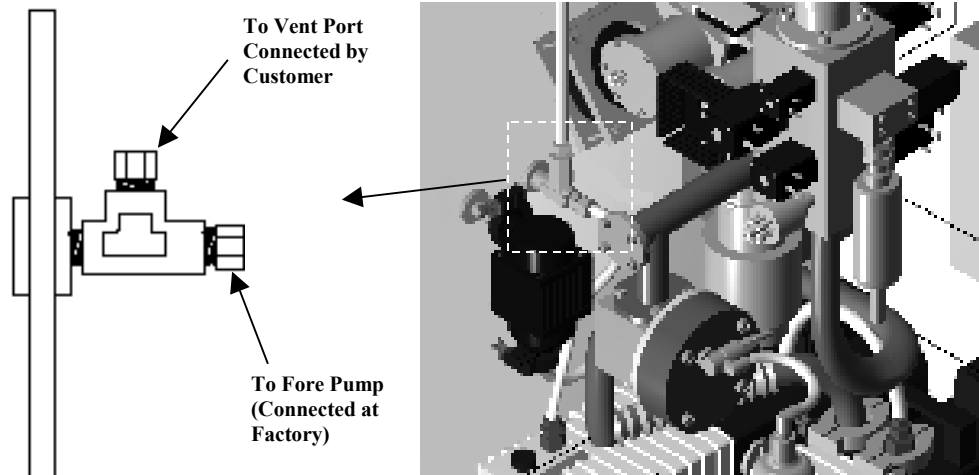

To connect the tubing, remove the unit’s left side access panel. The tubing is connected to the valve block at the **Vent** port. Remove the sintered metal filter from the tube end. Remove the cap fitting from the tubing “tee.” Attach the tubing to the Nitrogen bulkhead as shown in figure 1-1. Finally, the MS-50 should be connected to a facilities nitrogen supply (set for a pressure between 2.0 and 5.0 psi), via the purge port (labeled **NITROGEN**) located on the rear of the unit. The recommended Flow Rate is between (1.5-2.0 SCFH). Note, Venting large volumes may result in increased gas usage.

1.3 MS-50 Accessory Kit

An Accessory Kit (P/N 0139-800-00) is included with the leak detector, containing the following parts:

Description	Part No.
Filament Kit	0103-141-01
Mechanical Pump Oil (2 liters)	1990-900-01
Cartridge, Filter	0131-709-00
Funnel	1330-129-00
Allen Wrench 7/64	1330-391-00
Air Intake Filter (2)	1180-245-00
1 1/8" Quick Connect-to- KF 25 Adapter	1621-203-01

1.4 MS-50 Features

Start-Up

The MS-50 is ready for use less than 3 minutes after power is turned on. Start up consists of turbo pump acceleration, self-diagnostic checks, high vacuum system status check, system-offset measurement, background helium measurement, and turning on the mass spectrometer filament.

Testable Masses

Helium Mass 4 or Mass 3.

Internal Calibrator

1 x 10⁻⁸ to 3 x 10⁻⁸ std cc/sec air equivalent Helium Mass 4 leak standard with integral solenoid valve and thermal sensor for temperature compensation.
Traceable to NIST.

Tuning & Calibration

Calibration of Reverse and Direct Modes For Mass 4:

One-button automatic tuning and calibration using internal, temperature compensated leak standard (see above).

Calibration of Gross Mode: Manual.

Calibration for Mass 3: Approximate, based on Mass 4 calibration; requires user checking with external calibrator and possible manual adjustment of gain.

Cal Check

Provides one-button, automatic checking of system calibration.

Auto Zero

Allows operator to cancel out, or “zero”, any residual helium in the system introduced through the test port or test object.

Background Compensation

Continuous automatic compensation for system background.

Hand Held Remote Control Unit (optional)

Tactile membrane switch array in molded plastic case. Controls similar to User Panel. Allows simple, automatic leak testing up to 100 feet from MS-50.

RS-232C Ports

Two standard bi-directional ports. One port dedicated to the remote control unit. The second port is dedicated to data transfer to or from an external computer or control module.

Ranging (Automatic)

Starts in the 10^{-3} range if **Gross Screening** is selected. If Gross Screening is not selected, the MS-50 starts at the least sensitive range (10^{-4} if MS-50 is in Automatic flow mode switching or locked into Reverse mode; 10^{-5} if MS-50 is locked into Direct flow mode). If a larger leak is detected, the unit ranges up to the appropriate decade. If a gross leak is not detected, the unit ranges downward until a leak is detected or until it reaches its most sensitive range.

NOTE:

If the unit is set for Automatic flow mode switching or Direct Flow only, the most sensitive range is 10^{-10} . If the unit is set for Reverse flow only, the most sensitive range is the 10^{-9} range.

Ranging (Manual)

May operate at any range selected by the operator.

Flow Modes

The MS-50 uses both **Direct** and **Reverse** flow modes. The leak detector may be set to automatically switch between modes, based on leak rate and test port pressure, or set to be locked in to either Direct or Reverse flow testing.

Measurement Units**Pressure:**

milliTorr, millibar, or Pascal.

Leak Rate:

Std cc/sec (standard cubic centimeters/second), mBar l/sec (millibar liters/second), Pascal m³/second (Pascal meters cubed/second).

Pumps**Roughing Pump:**

16-cfm dual stage rotary vane mechanical pump.

Turbo Pump:

52 liter/second hybrid turbo/drag pump. Magnetically suspended bearing.

Foreline Pump:

7-cfm dual stage rotary vane mechanical pump.

1.5 MS-50 Performance Specifications**Sensitivity**

Reverse Flow Mode: 3×10^{-10} std cc/sec air equivalent

Direct Flow Mode: 3×10^{-11} std cc/sec air equivalent

Leak Rate Range: 10×100 to 3×10^{-11} std cc/sec air equivalent

Resolution

14 at Mass 4

Response Time

Gross Mode:	Less than 3 seconds
Reverse Flow Mode:	Less than 2.5 seconds
Direct Flow Mode:	Less than 2 seconds

Time To Test

Reverse Flow Mode: Less than 1.5 seconds on a blank port to a pre-selected range.

Direct Flow Mode: Less than 6 seconds on a blank port to a pre-selected range.

Noise & Drift

Reverse Flow Mode:	3% or less on 10^{-9} range
Direct Flow Mode:	3% or less on 10^{-10} range

Testable Masses

3, 4

Maximum Measurable Leak

10 x 100 std cc/sec air equivalent

Test Mode Maximum Crossover Pressure (Torr)

Gross Mode:	100.0
Reverse Mode:	10.0
Direct Mode:	0.2

Test Mode Leak Rate Ranges (std cc/sec air equivalent)

Reverse:	10×10^{-4} to 0.3×10^{-9}
Direct:	10×10^{-5} to 0.3×10^{-10}
Gross:	10 x 100 to 0.6×10^{-4}

1.6 Electronics & User Interface

System Computer/Controls

Embedded PC compatible computer with PC104 format. Four integrated circuit boards are used in the MS-50:

Board A: Main control board with leak rate amplification and pressure gauge circuitry.

Board B: Mass Spectrometer power supply board.

Board C: User interface board.

Board D: Handheld remote control board.

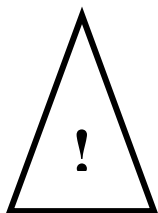

WARNING!

Only qualified service personnel should operate the unit when the unit's electrical access (right side) panel is open. Potentially lethal high voltages are continually applied to the circuit boards and other areas within the unit during its operation. Although these areas are shielded and well marked, failure to follow this precaution may possibly lead to severe injury or death.

Display

The MS-50 features a 9" color VGA cathode ray tube (CRT) display. The CRT is mounted at the top right corner of the unit on a tilt and swivel base.

User Panel

The MS-50 operation and service controls are included on a User Panel comprising two tactile membrane type boards. Discrete switches are provided for the **Start** and **Vent** functions. The User Panel is located on the front sloped section of the console table top, and is recessed to prevent accidental actuation of its switches. A sliding door covers the Service section of the panel and the lesser-used functions of the Control section.

Users Panel functions and CRT screen interface are discussed in detail in Chapter Two.

1.7 Power Requirements

Power Requirements:

The MS-50 may be configured at the factory to operate at the following voltage/frequency combinations:

115V, 60Hz, 30Amp
230V/50Hz, 15 Amp
100V/50Hz, 30 Amp
115V/50Hz, 30 Amp

1.8 Dimensions & Weight

Dimensions:

Height: 35 1/4" (89.6 cm), to tabletop.

Width: 25 3/4" (65.4 cm).

Depth: 30 5/8" (77.8 cm).

Shipping Weight:

475 lb. (216 kg), crated.

1.9 MS-50 General Description

The MS-50 is a fully automatic, dual mode, turbo pumped console leak detector. In **Automatic** flow mode selection, Reverse Flow and Direct Flow modes are automatically selected by the leak detector based on the currently selected leak rate range.

Reverse Flow Mode

Permits rapid testing for leaks in test objects that are characterized by a high degree of outgassing. Testing can start at test port pressures of 10.0 Torr for leaks between 10×10^{-4} and 0.3×10^{-9} std cc/sec.

Direct Flow Mode

Direct mode is most useful for testing objects that demand more sensitive and relatively clean leak testing. In this mode, the leak detector measures leaks from 10×10^{-5} to 0.3×10^{-10} std cc/sec, at a test port pressure of 0.2 Torr or less.

Gross Leak Testing

Gross leak testing commences at test port pressures of 100 Torr (a fixed setting). During Gross leak testing, the MS-50 will test for leaks from 10×10^0 to 0.6×10^{-4} std cc/sec. Gross testing may be used with both Reverse and Direct flow modes.

Keyswitch/Operational Mode Selection

A three-position keyswitch on the front of the MS-50 is used to select the following operational modes:

Automatic Test Mode (Norm):

This is the normal operating mode for the MS-50. In Test mode, all valve openings and closures are performed automatically by the system computer. The CRT monitor screen displays bar graphs indicating test port pressure and leak rate values, ranging mode (Auto or Manual), an Accept/Reject indicator (that alerts the operator whether the size of the leak being tested is above or below a pre-selected reject set point), and whether the unit is in **Leak Testing** or **Ready to Test** (standby) mode.

Settings Mode (Set):

This is a semi-protected mode of operation. In **Set** mode, the system computer is responsible for controlling all valve openings and closures. Set mode differs from **Norm** (Test) mode in that it allows the operator to change system setup parameters (such as Reject Point, Gross and Sniff mode gains, crossover pressures). Set mode is intended for use by an experienced operator or a supervisor. There is no chance of inadvertent valve opening or closing by the operator in the Set mode.

Service Mode (Service):

Service mode disables the automatic valve controls and allows the user to manually control all of the valves within the vacuum system. The valves are controlled by a cluster of labeled momentary switches located on the User Panel. The LED indicator on each switch is lit when the valve is open. Included within the vacuum system are: the calibrator valve, direct valve, foreline valve, gross testing valve, reverse valve, rough valve, sniff valve, and the vent valve.

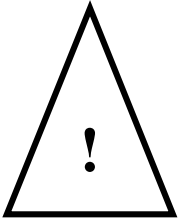
**WARNING!**

The MS-50 Service Mode is intended for use by qualified Vacuum Instrument service personnel or operators specially trained by Vacuum instrument technicians. Service mode is "unprotected", that is, the system will not automatically protect the vacuum system components from inadvertent damage due to operator error while in Service mode.

Under no circumstances should any individual be assigned access to this mode without a thorough knowledge of vacuum systems in general, and the MS-50 system specifically. Use by an unqualified operator may result in damage to the unit and/or personal injury.

Each of the modes and setting options mentioned here briefly are examined in detail in the chapters that follow.

2.0 Introduction to Leak Detection Theory & Methods

When designing and manufacturing systems that contain gases or fluids, or systems that are normally evacuated, the manufacturer/tester must take into account the degree of leakage that can occur. To qualify these products, various methods may be selected to test these products for leaks. The amount of actual leakage that can be tolerated is different for every application and therefore must be determined from the conditions of the application itself. From this data the manufacturer will be able to establish the limits of maximum permissible leakage standards and will also be able to determine the maximum permissible pressure levels within a product or system under actual working conditions. Further, the manufacturer will need the ability to discover and localize any leaks in the product or system tested. In all cases, the maximum allowable leak rate, as well as the testing methods and procedures, should be specified before a product or system is manufactured.

Many commercial, industrial and military products and processes require hermetic sealing. In general, these products include equipment exposed to pressures above or below those of its immediate environment, vacuum equipment used in the manufacture of semiconductors and related research, and items produced for industrial and commercial applications, most notably the refrigeration and automotive industries. Hermetic tightness (sealing) is narrowly defined as the absence of leakage; however, no manufactured object can be considered leak tight. Statements such as “no detectable leaks” or “zero leakage” are not valid specifications for acceptance testing. Even in the absence of defect within a product or system, gas will always permeate through metal, crystals, polymers and glasses. Therefore, leak tightness is only a relative term.

The degree of permissible leakage depends on how and where the product or system is to be used, the amount of the object’s content (liquid or gas) that is permitted to escape over a certain time period, or the amount of external atmosphere or liquid that is permitted to penetrate the object over a certain time period. The size of the permissible leak is defined as part of the performance requirements of the product or system. Leak standards are necessary for the following reasons:

- To prevent the loss of contained gases or liquids.
- To prevent hazards caused by escaping toxic materials.
- To prevent contamination due to materials leaking from or leaking into an object.
- To test the projected reliability of sealed systems or the components within the systems.

When setting the limits of allowable leakage, it is always necessary to set a practical leakage level for the product under testing. Decreasing the permissible leak rate below a practical level and increasing the sensitivity of the required test method only brings with it an unnecessary increase in the time required and the cost of performing a test.

Leak testing is divided into two general categories, **Leak Measurement** and **Leak Location**.

Leak measurement is the quantified assessment of an object or system's leak rate and is also the preferred method of determining that a leak does exist. Leak location is the process of pinpointing the precise location of individual leaks. When testing an object, the most reliable sequence is to first measure the total leakage of a test object, then, if necessary, determine the location of individual leaks.

A leak rate specification should take into account the effect of leakage on the system and its application. Long term storage of the object or system may be necessary and should be considered when creating a leakage standard.

Any leak detection procedure requires careful planning. Ample consideration to test sensitivity and response time is required when testing any object. At times, it may be preferable to specify a maximum tolerable leakage rather than specifying a maximum allowable leak rate. The maximum tolerable leak rate may be calculated by multiplying the maximum allowable leak rate by the length of time a system or object is expected to be used (including storage time). If a gas or liquid is not introduced to the system or object until it becomes operational, the maximum tolerable leakage need be only specified for the duration of its operation. The level of the maximum

tolerable leakage should always be specified when the total amount of leakage is more important than the leak rate.

A commonly used method for determining the maximum allowable leak rate is derived from the consideration of leaks in the following situations:

- System failure during the operational life of the system.
- Hazards to personnel and equipment when leaks occur.
- Unacceptable appearance of the system.
- Assurance of proper design and construction of the manufactured equipment.

In determining system specifications, the smallest leak rate will be the maximum allowable leak rate. If the content of the test object is liquid, it is necessary to correlate the maximum liquid leak rate to the leak rate of helium. Once the maximum leak rate of the liquid in the test object has been calculated, it is very simple to conduct an accurate leak test for an object designed to contain liquid, since calibrated helium gas standard is an integral part of the MS-50.

Of all the instruments and devices used for leak detection, helium-sensitive mass spectrometer based leak detectors such as the MS-50 have been proven to be by far the most sensitive and accurate. This type of unit is generally easily calibrated, does not depend on user judgement to be operated effectively, and most importantly, is not destructive or harmful to test personnel or the tested object.

2.1 Functional Description of MS-50 Leak Detector Operation

The MS-50 Automatic Leak Detector is a helium-based mass spectrometer leak detector that may be used for both quantifying and locating leaks in objects that can be evacuated or pressurized. Helium that is present in a test object is drawn into the unit (either through the test port or through the sniffer valve), isolated and detected by a mass spectrometer, and converted into an electrical signal. The electrical signal generated is proportional to the leak rate of the helium drawn through the leak found in the test object. Once this signal is amplified, the signal is displayed as a leak rate on the CRT screen.

Helium is used as a tracer gas because of its unique combination of properties:

- Helium is present in the atmosphere at a rate of only five (5) parts per million, therefore it is unusual to find a high atmospheric background of helium that may disrupt testing.
- Helium is neither explosive nor toxic; it is completely inert and will not contaminate a test object.
- Helium does not contaminate or desensitize its own detector, as is common with detectors using other tracer gases.
- Helium molecules are small and therefore flow readily through extremely small leaks.

2.1.1 The MS-50 Test Cycle

This section describes the sequence of a typical MS-50 test cycle. It is intended to familiarize you with operation of the unit's vacuum system and other major components, and to provide you with a general overview of leak testing with the MS-50.

NOTE:

*In the example that follows, the **Automatic** flow mode switching has been selected, and the unit's **Gross Screening** option is **On**. Each of the unit's various testing flow mode configurations are explained in step-by-step detail in **Chapter 3, Operating the MS-50**.*

Prior to testing, the unit must be in **READY TO TEST** status (the system start up procedure is described in Chapter 3). In **READY TO TEST** status:

1. The internal rotary vane mechanical pumps (i.e., Rough and Fore pumps) and the turbo-molecular pump are functioning.
2. The foreline valve is open; all other valves are closed.
3. The high vacuum system has been fully evacuated by the turbo pump, and the filament has been turned on.

After connecting a test object to the test port, the operator presses the **START** button, initiating the pump down/test cycle. The **Rough** valve opens, and the roughing pump begins to evacuate the test object. The falling pressure within the test port is monitored by a pirani gauge attached to the test port.

When the test port pressure drops to 100 Torr, the **Gross** valve opens, and leak testing commences in the 10^{-3} range. The CRT display will indicate that the unit is now **LEAK TESTING**; spraying of the test object with helium should now commence.

The sample gases introduced from the test object disperse throughout the confines of the hi-vac system. As gas molecules enter the ion source chamber of the mass spectrometer, an electrically heated filament provides a source of electrons that collide with the gas molecules and produce positively charged ions. The production of these ions is referred to as **ionization**. Due to the differences in mass of the ionized gases, only helium ions have the ability to traverse the two 90-degree magnetic sections of the spectrometer housing to the collector. Ions at the collector are converted into electrical current, then processed by the MS-50 computer and displayed on the CRT screen as a leak rate value.

If a leak is not detected in the Gross ranges (ie, 10×100 to 0.6×10^{-4} std cc/sec air equivalent) the unit checks the test port pressure to determine whether it may "crossover" into Reverse Flow mode. When the vacuum system crosses over from Gross to Reverse mode, the **Reverse** valve is

opened and the Gross and Rough valves close; the Foreline valve remains open. All other valves are closed.

During crossover, the equalization of pressures may cause a temporary increase in foreline pressure. This increase is termed a **burst**, and is monitored by a Pirani gauge in the foreline. If the burst causes the foreline pressure to increase to over 7,000 mTorr, the test will be halted and the

MS-50 will return to **Ready to Test** mode.

If a burst causes foreline pressure to increase to over 8,500 mTorr (a highly unlikely circumstance, except when testing large or exceptionally “gassy” test objects at a very high crossover setting), the unit will be shut down.

The Reverse crossover pressure set point should be adjusted by the operator to provide the shortest possible test cycle duration without producing excessive pressure bursts into the foreline region of the unit (since foreline tolerance is very high, the usual result of the increase of foreline pressure will be a variable background reading).

The maximum allowable crossover pressure set point for Reverse mode is 10 Torr. When crossover pressure is reached, Reverse testing begins in the 10^{-5} range

NOTE:

If Gross Screening is off, Reverse testing starts in the 10^{-4} range.

If no leak is detected in any of the Reverse mode ranges (10×10^{-5} to 0.6×10^{-9} std cc/sec), the unit checks the test port pressure to determine whether it may crossover into Direct flow testing mode. The crossover pressure set point for Direct mode may be set by the operator to a maximum of 200 mTorr.

NOTE:

The Reverse flow mode sensitivity range extends to 0.3×10^{-9} , however, direct crossover in automatic testing mode occurs at 0.6×10^{-9} .

When the vacuum system crosses over from Reverse to Direct mode, the **Direct** valve opens, and the **Reverse** valve closes; the **Foreline** valve remains open. At this point, the test port is fully connected to the high-vacuum section; pressure in the test object continues to be reduced until it

is equalized with the pressure in the high-vacuum section. The equalization of the two pressures causes a burst in the high-vacuum section. If the burst causes the high vacuum pressure to increase to over 5×10^{-4} Torr, the system will turn the filament off.

After a fifteen-second interval, the unit will once again check the high vacuum pressure. If pressure is still high, the filament remains off. The unit will keep checking every fifteen seconds until the high vacuum pressure returns to acceptable levels or the test cycle is aborted. To prevent an excessive pressure burst, the test port may be evacuated for a longer period by:

1. Lowering the **Direct Crossover** setpoint.
2. Changing the **Direct Crossover Delay** setting (delaying the opening of the Direct valve).

NOTE:

Refer to Chapter 3 for detailed information on adjusting crossover and delay parameters.

Optimizing these two parameters allows the MS-50 operator to shorten the test cycle while still being able to safely operate the unit. Often, the setting

of crossover delays will depend on the size of the test object. Smaller, cleaner objects will tend to produce small pressure bursts and therefore use relatively high crossover setpoints. Larger, dirtier objects tend to produce larger bursts; delaying the crossover to Direct flow mode can prevent such bursts by extending the rough pump down time.

In Direct mode, the MS-50 searches for leaks in the 10×10^{-5} to 0.3×10^{-10} range, ranging downward to the ultimate Direct mode sensitivity of 3×10^{-11} std cc/sec, unless a larger leak is found.

After any leaks in the test object are detected and quantified, the test is terminated by pressing **VENT** button. The MS-50 computer will then close all valves except the Foreline valve. After the **VENT** button is held down by the operator for a time exceeding a user-determined **Vent Delay** setting (the default setting is 0.5 seconds), the **Vent** valve is opened. The opening of the Vent valve brings the test object to atmospheric pressure, allowing it to be removed from the test port.

If the ambient air in the testing area has a high moisture content, it is advisable to purge the unit with dry nitrogen. Using dry nitrogen prevents water vapor from collecting in the unit, which then must be pumped out during the next testing cycle (see section 1.2 for additional information).

2.1.2 Power Failure Protection

In the event of a power failure, all valves within the vacuum system will automatically close. The rough pump and the turbo pump will shut off (it will, however, take several minutes for the blades of the turbo pump to stop spinning). When power is restored, the unit will automatically begin its normal power-up sequence.

If the filament was **on** prior to the power failure, the unit will turn the filament on after power up. If the filament was **off** prior to the power failure, the operator must manually activate the filament by either pressing the **FIL ON/OFF** key (located on the User Panel) or pressing the **START** switch.

After the filament is turned on, the system computer will prohibit any testing from occurring for fifteen seconds so that the system may acquire accurate background measurements. During this time, the MS-50 will emit an audible "beep" whenever the **START** switch is pressed. At the end of the fifteen-second delay, a test cycle may be commenced normally by pressing the **START** switch.

NOTE:

*If the MS-50 was in **Sleep** mode prior to power failure, it will return to Sleep mode after recovering.*

2.2 Leak Testing Flow Modes

The MS-50 is capable of detecting leaks using both **Reverse** and **Direct** flow modes. The leak detector may be set to automatically switch between modes, based on leak rate and test port pressure, or specifically locked into either Direct or Reverse flow mode testing.

2.2.1 Reverse Flow Mode

For the MS-50, the Reverse flow mode leak range is defined as 10×10^{-4} to 0.3×10^{-9} std cc/sec. Reverse mode is particularly useful for detecting and measuring leaks in test objects that have a high degree of outgassing or when a fast crossover at a high test port pressure is desired. The Reverse valve and Foreline valve are open during Reverse mode testing. All other valves remain closed.

When testing in Reverse mode, the foreline pressure is usually in the 10^{-3} Torr range or greater; the turbo pump actually acts as a buffer against pressure bursts into the high vacuum region (the area containing the mass spectrometer). Therefore, crossover can occur at much higher pressures in Reverse flow mode than in Direct flow mode.

When the test port pressure reaches a pre-designated setpoint (10.0 Torr max) the unit will "crossover" (the actual point of crossover may be set by the system operator). At crossover, the Reverse valve opens, after which the Rough valve closes.

2.2.2 Direct Flow Mode

The Direct flow mode is best suited to testing clean parts that have more sensitive leak rate requirements, particularly those with leak rate specifications less than 0.3×10^{-9} std cc/sec. In this mode, the test object gases are directly routed into the high vacuum section and then the mass spectrometer. This allows for much higher sensitivity and ultra-clean testing in comparison to Reverse flow mode, but requires a much lower crossover pressure.

During Direct flow mode testing, the Direct valve and Foreline valves are open. All other valves are closed. Crossover typically takes place when the test port pressure is at approximately 25 to 50 mTorr (the Direct crossover pressure setpoint can be adjusted by the operator, to a maximum 200 mTorr). The Direct mode test leak range is between 10×10^{-5} to 0.3×10^{-10} std cc/sec.

2.2.3 Gross Leak Testing

Leaks falling in the 10×100 to 0.6×10^{-4} range are referred to as **Gross** leaks, and are detected using a variation of a direct flow method. In Gross mode, the Rough, Gross, and Foreline valves are open; test gases are drawn directly to the unit's mass spectrometer through a constriction which prevents vacuum system contamination, regardless of whether Reverse or Direct flow mode is selected.

If the MS-50 is set for **Automatic Ranging**, the user may toggle **Gross Screening** function on or off.

If Gross Screening is **on**, the unit starts checking for leaks in the Gross Mode (10^{-3} range) first, then ranges up or down to the level of the leak. If Gross Screening is **off**, the MS-50 will begin leak testing in the least sensitive range available, depending on the flow mode selected. If a gross leak is subsequently detected, the MS-50 will range upward and switch to Gross leak testing mode.

(Note: Refer to Chapter 3 for additional information on Gross Screening)

FIGURE 2 -1 REVERSE FLOW PATH

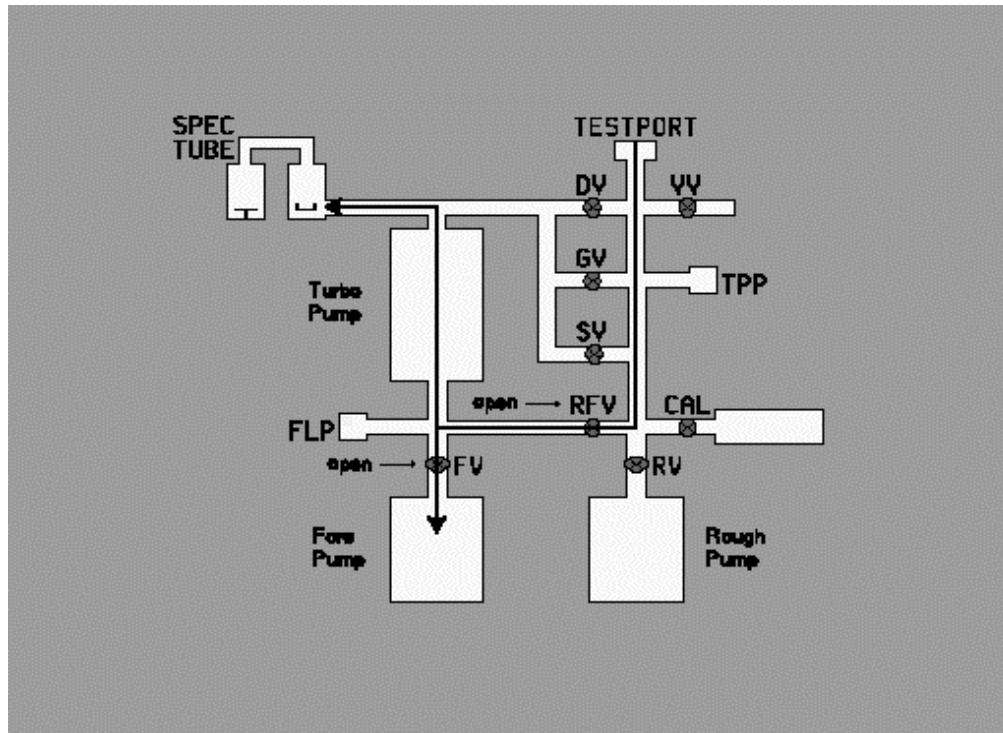
**Notes:**

- Reverse (RFV) and Foreline (FV) valves open.
- Gases from test sample are introduced to foreline of turbo pump.
- Heavier gases such as nitrogen and oxygen are prevented from entering the Hi-Vac area, but lighter gases such as helium will backstream up (ie, turbo/drag pump has high compression ratio for heavier gases).
- Hybrid turbo/molecular drag pump acts as buffer to pressure. Allows leak testing at high pressures.

FIGURE 2 - 2 DIRECT TESTING FLOW PATH

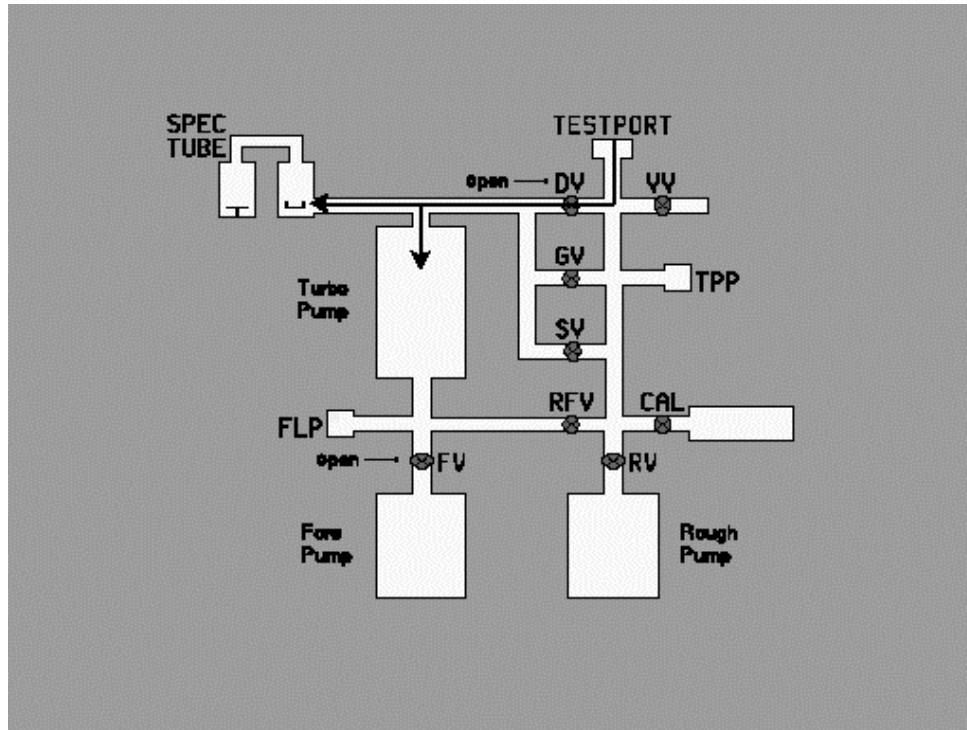
**Notes:**

- Only Direct (DV) and Foreline (FV) valves are open during testing.
- Test gases drawn directly to top of turbo pump and to mass spectrometer.
- Most sensitive leak testing mode; fastest response to leaks.
- Because there is no restrictor on the Direct valve (see Gross Mode notes), Direct mode testing requires that test object be pumped down further before crossover to prevent excessive HiVac “burst” at crossover.

FIGURE 2 – 3 GROSS TESTING FLOW PATH

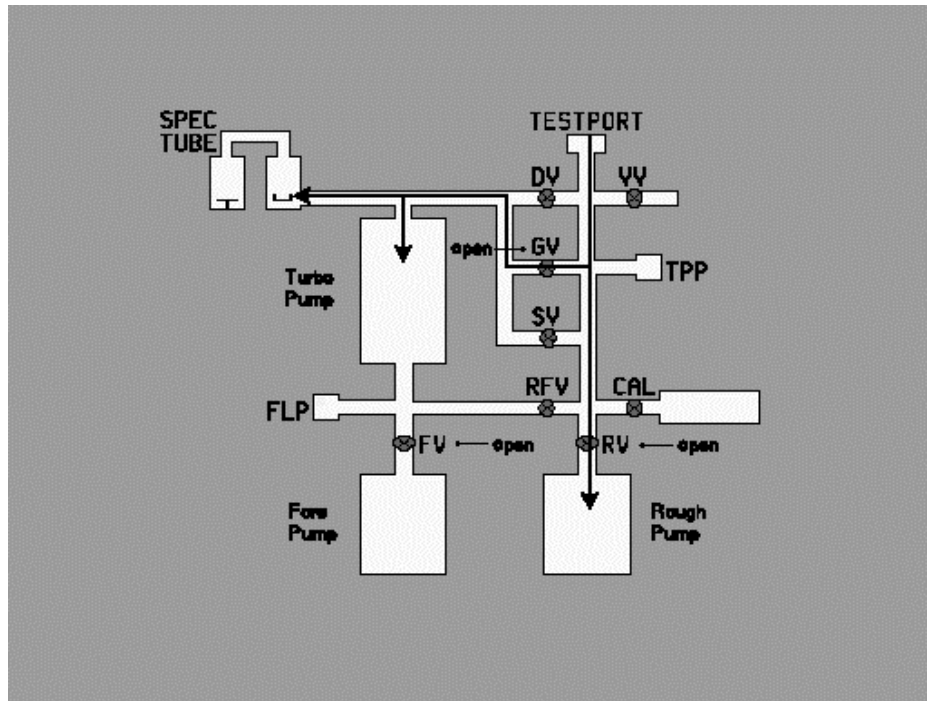

Notes:

- Roughing (RV), Gross (GV), and Foreline (FV) valves are open.
- Some helium from test object goes to the roughing pump, some is drawn through gross valve.
- Gross valve has restriction (sintered metal leak) which attenuates both pressure and helium across valve.
- Only 1/100,000 of helium at test port reaches mass spectrometer, with crossover at 100Torr - this protects the mass spectrometer filament against excessive pressure and prevents flooding high vacuum area with helium.

2.3 Description of Major Components

2.3.1 Vacuum System

Mass Spectrometer

The mass spectrometer is the component of the vacuum system that detects the helium tracer gas present in the test object. The unit ionizes the gas molecules, separates the helium ions from other gas ions, and converts the helium ions into an electrical current that represents the size of the leak. The spectrometer consists of three major sections:

- The **Source** (gas to ion converter)
- The **Magnetic Deflector Assembly**
- The **Ion Collector**

Source (gas to ion converter - for ion production): To permit neutral atoms and molecules of gas to be separated by a magnetic mass spectrometer, they must first be converted to positively charged ions. This conversion occurs in the ion source. Inside the ion source is an electrically heated

filament that provides a source of electrons. As these electrons collide with gas molecules, they split off electrons from the gas molecules and create positively charged gas ions. These ions then encounter electrostatic fields created within the ion source by the ion repeller, the ion chamber, the focusing plates and the object plate. The end-result of this arrangement is to accelerate the gas ions into a well defined, mono-energetic beam.

Magnetic Deflector Assembly (for ion separation): Since the gas entering the spectrometer contains atoms and molecules of different kinds, the ion beam will likewise contain a variety of ions including nitrogen, oxygen, carbon dioxide, and, if a leak exists, helium. Magnets are mounted on the outer portion of the spectrometer, outside of the vacuum system, and are used to create magnetic fields that are perpendicular to the beam of gas ions. A magnetic field causes the ions to deflect off their current trajectories; the amount of deflection depends upon the mass of the gas ion. Lighter ions such as hydrogen are deflected to a greater extent than heavier ions such as oxygen.

Two identical magnetic fields are used in the MS-50's mass spectrometer. The first magnetic field is organized so that only helium has the necessary mass to pass through the field and through the narrow opening in the baffle on the far side of the magnetic field. Most of the other ions will be deflected in a different direction (they will be either too heavy or too light) and will be intercepted by the baffle. A few of the non-helium ions will be able to pass through the baffle (due to random scattering and bouncing of the ions within the mass spectrometer). Therefore, a second identical magnetic field and baffle is used again, which acts to virtually eliminate all ions except for helium ions. By using this construction of two separate magnets and baffles, helium is selectively transmitted to its target, while other gases, even if present in large quantities, are rejected.

Ion Collector: After passing through the magnetic fields and baffles of the spectrometer, the gas ions encounter a **slit plate** (a plate with a thin and narrow aperture). Behind this plate is a metal plate, termed the **target**. As helium ions strike the target, the target becomes positively charged, causing an extremely small electron flow (as low as 1×10^{-15} amperes). The current flow is detected and magnified by an amplifier within the collector. The first stage of amplification takes place within the high vacuum environment to assure stability and reduce stray noise pick-up. The amplified signal is proportional to the partial pressure of helium within the source. This signal is processed by the MS-50 computer and, finally, displayed on the CRT as a **leak rate** value.

2.3.2 Valve Block Assembly

The valve block assembly comprises the following components:

- **Calibrator Valve (with Calibrator Assembly)**
- **Direct Valve**
- **Foreline Valve**
- **Reverse Valve**
- **Gross Valve**
- **Sniffer Valve**
- **Vent Valve**
- **Vent Line Connection**
- **Test Port**
- **Test Port Pirani Gauge**
- **Foreline Pirani Gauge**
- **Rough Valve** (*not attached to valve block; see description below*)

Calibrator Valve:

A three-way valve that connects the calibrator to the test port. This valve keeps the calibrator at atmospheric pressure when not in use.

Direct Valve:

Connects the test port to the high-vacuum section (mass spectrometer housing) during Direct Mode testing.

Foreline Valve:

Connects the foreline of the turbo pump to the Fore pump.

Reverse Valve:

Connects test port to foreline of turbo pump during Reverse Mode testing.

Gross Valve:

Connects the test port to the high vacuum section (through a restriction) during Gross Mode testing.

Sniffer Valve:

A pulse modulated valve, which connects the sniffer port to the high vacuum section during sniff testing.

Vent Valve:

Connects the test port to atmosphere through a sintered metal filter or to facilities dry nitrogen through a rear bulkhead connector.

Vent Line Connection:

1/4" polyflow tube fitting and tubing. May be connected to rear bulkhead to vent to dry nitrogen. The MS-50 is shipped with a sintered metal filter that prevents particles from being drawn into the valve block during venting.

Test Port Pirani:

A pressure gauge that monitors the test port pressure from atmosphere to 10^{-3} Torr.

Test Port:

A standard 1 1/8" quick connect vacuum connection is used to attach test objects to the MS-50. A 1 1/8" quick connect - to - KF25 adapter is included in the MS-50 accessory kit.

Foreline Pirani:

A pressure gauge that monitors the foreline pressure from atmosphere to 10^{-3} Torr.

Rough Valve:

The Rough Valve is a large (1 3/8" diameter) bellows valve connecting the test port to the Roughing pump for initial evacuation of the test object. It is located to the side of the valve block on the roughing manifold.

2.3.3 Pumps**Roughing Pump:**

A 16 cfm dual stage rotary vane mechanical pump, used for initial evacuation of the test port and test object. The pump is capable of reducing pressure from atmosphere to 10^{-3} Torr.

Foreline Pump:

A 7 cfm dual stage rotary vane mechanical pump. Provides backing for the turbo pump.

High-Vacuum Turbo Pump:

A 52 liter/second hybrid turbo/molecular drag pump.

2.3.4 Calibrator

An internal temperature-compensated calibrator that leaks Helium 4 at a rate between 1×10^{-8} and 3×10^{-8} std cc/sec air equivalent, traceable to NIST (National Institute of Standards and Technology), is standard equipment with every MS-50. External calibrator models of differing ranges are also available. Contact Vacuum Instrument for further information.

3.0 Introduction

This chapter is intended to familiarize the user with the basic controls and procedures used in leak detection with the MS-50. Wherever possible, reproductions of actual MS-50 onscreen menus have been included to illustrate the functions being explained.

The chapter is organized into three general sections:

Leak Detector Controls and Connections explains the function of each switch on the MS-50 User Panel, as well as the external connections to the unit.

Leak Detector Operation provides step-by-step instructions for leak testing in each of the MS-50's test modes.

Setting Test Parameters explains each of the user-selectable test parameters accessible from the onscreen setting menus.

While this chapter provides sufficient information to operate the MS-50 leak detector, it is strongly recommended that you read *Chapter 2: Theory of Operation*, prior to performing any testing. An overall understanding of the various phases of the test cycle will help you to use the leak detector more effectively, efficiently, and safely.

3.1 MS-50 Main Controls and Connections

3.1.1 Front Panel Controls

Located on the front of the MS-50 (below the User panel overhang) are the following controls:

Power I/O Switch

Main power-switch to the MS-50. When switched, the power up sequence is initiated.

Key-switch

A three-position switch used to select the following MS-50 operational modes:

Right Position: **Service** Mode

Center Position: **Norm** (Test) Mode

Left Position: **Set** Mode

Audio Speaker / Audio Headphone Jack:

A mini speaker is positioned below the front panel controls to enable audio monitoring of MS-50 leak tests. Speaker volume is adjusted using the **Audio** up/down arrow buttons on the User Panel.

A jack near the speaker enables a set of headphones to be used during audio monitoring of MS-50 leak tests in noisy environments.

3.1.2 Rear Panel Connections

Printer

Allows a PC-compatible printer to be connected to the unit via a standard 36/25 pin parallel cable. When a printer is connected to the unit, testing data is sent to the printer whenever the user stops a test (either by pressing the **VENT** button or by pressing the **START** switch a second time).

The test data is encoded with the time and date of the measurement as well as the tested leak rate, leak rate units, Accept/Reject indication, Reject set point, and current test “recipe”.

Figure 3 – 1 A
Front Panel Controls

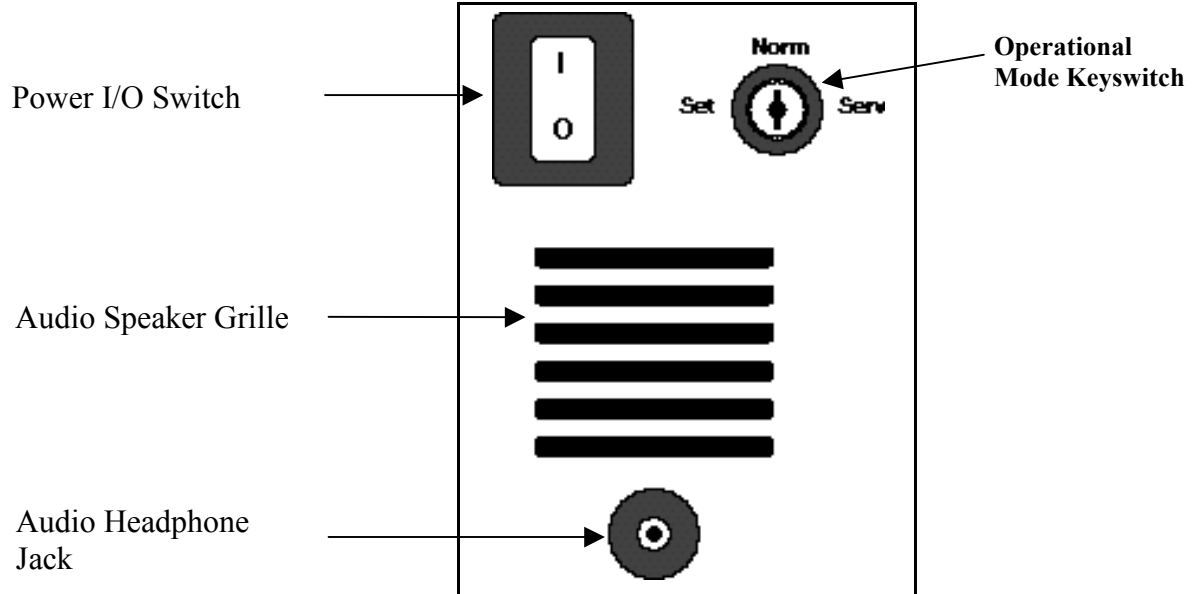

Figure 3 – 1B
Rear Panel Connections

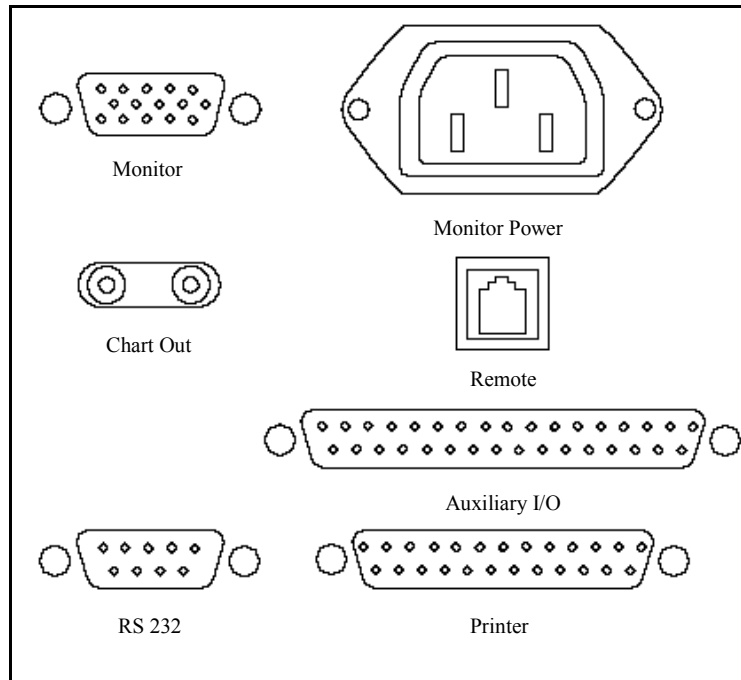
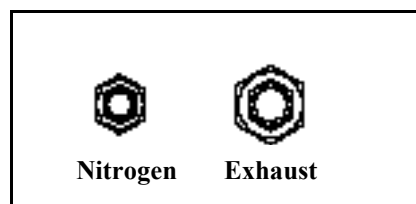

Figure 3 – 1c
Nitrogen &
Exhaust Bulkheads



Monitor Power

Dedicated plug supplies power to the MS-50's CRT computer monitor.

RS-232 Port (1)

9-pin serial connection; enables communication with external PC-compatible computer for remote control of MS-50 functions via a standard phone jack connector.

RS-232 Port (2)

Standard phone jack; enables communication with hand-held control panel for remote operation MS-50.

AC Power Connector

For supplying AC power to the MS-50. A standard plug/cord is used.

Chart

Two single-pin connectors providing a 0-5V DC output. Allows the use of a chart recorder, or similar device, to monitor leak testing in progress. Measures the leak rate mantissa.

Nitrogen

A standard bulkhead connector for 3/8" O.D. plastic tubing. Allows the user to connect a dry nitrogen source to the purge fitting on the foreline pump and to the vacuum system vent port.

Exhaust

A standard bulkhead connector for 1/2" O.D. plastic tubing. Allows the normal exhaust that the MS-50 produces during testing to be channeled directly to a user-provided exhaust system. Standard 1/2" O.D. tubing is used between the detector and the exhaust system.

3.1.3 The User Panel

1. Service Mode Controls

Turning the key-switch on the front of the unit 90° clockwise places the MS-50 in **Service Mode** and activates the Service Mode controls. A red indicator lamp lights when Service Mode is active.

FIGURE 3-2
MSSD User Panel

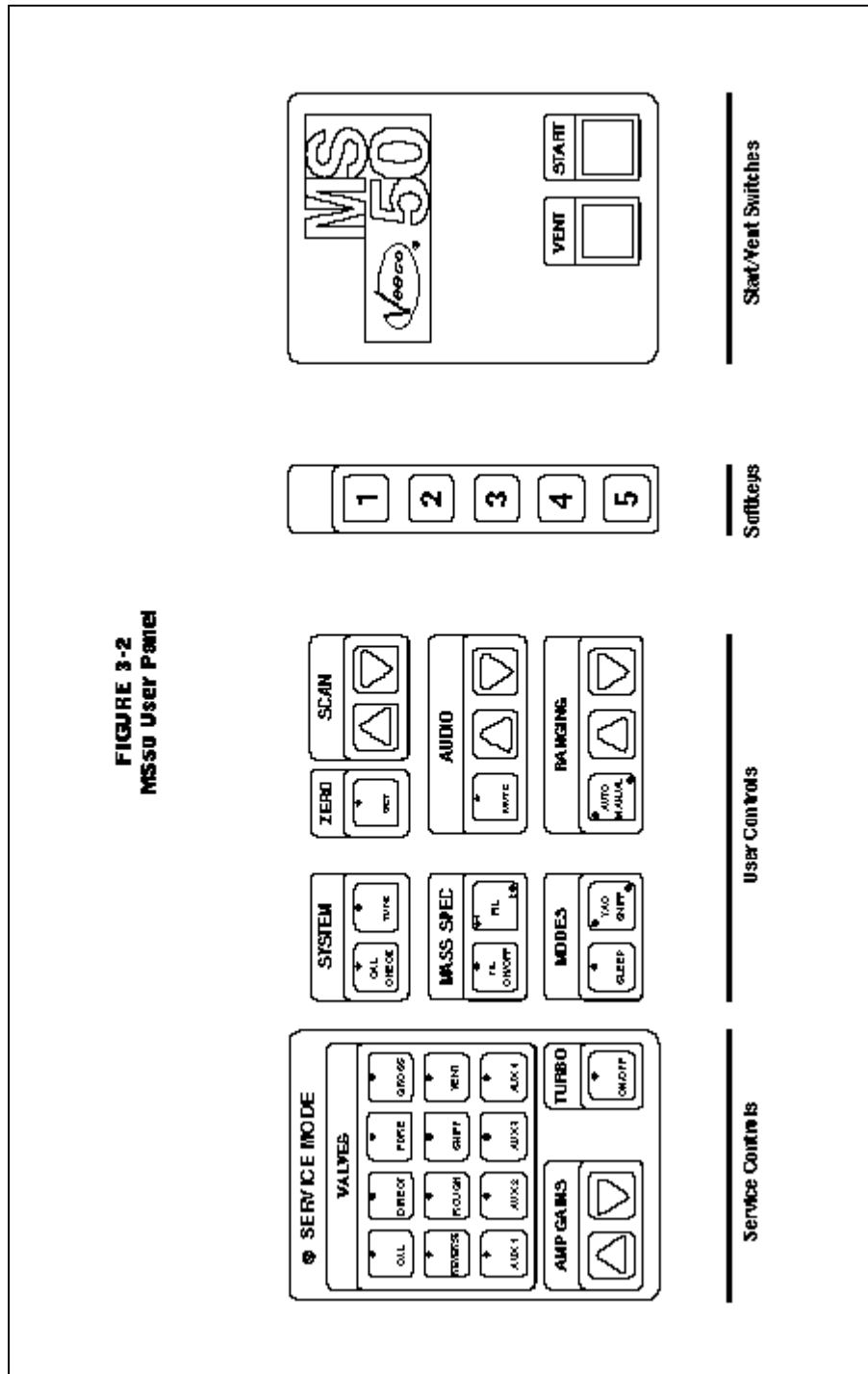

Valves

Toggle individual valves open and closed via this key cluster. Green indicator LED lights on the switches indicate **open** valves.

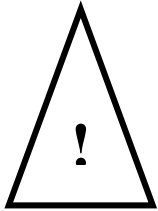

WARNING

Service Mode is intended to be used by specially trained operators or Vacuum Instrument service personnel only! Attempting to operate the MS-50 in Service Mode without advanced knowledge of vacuum systems and MS-50 service procedures can result in personal injury and damage to the leak detector.

The **Valve** switches are:

- **Cal (Calibrator)**
- **Direct**
- **Fore (Foreline)**
- **Gross**
- **Reverse**
- **Rough**
- **Sniff**
- **Vent**
- **Aux 1-4 (not assigned; used in MS-50 Dual Port and custom leak detector configurations)**

Amp Gains

Adjust the Amplifier Gain setting for the currently selected flow mode by pressing these arrow keys. The gain settings (**G1 - G4**) are displayed in the lower left corner of the Service mode vacuum system schematic screen.

G2 (Reverse flow mode gain) and **G3** (Direct flow mode gain) are normally computer controlled settings that can be manually adjusted while unit is in Service mode. **G1** (Gross mode gain) and **G4** (Sniff mode gain) can be manually adjusted in either Set or Service Mode.

Turbo

Toggles the turbo pump on or off.

2. Operator Controls (Normal/Set Mode)

System

Cal Check: Pressing this key initiates a calibration check sequence using the MS-50's internal calibrator.

Cal Check allows the user to verify the measurement accuracy of the MS-50 leak detector. The unit automatically connects the internal leak rate standard of the unit to the test port, measures the internal calibrator, subtracts the background helium measurement and displays the results on the Leak Rate bar graph display.

When the LED indicator on the Cal Check key begins flashing, the MS-50 has completed its measurement cycle. The Cal Check reading should then be compared to the temperature compensated value of the internal leak rate standard. The unit is considered to be measuring accurately whenever the two readings are within 10% of each other.

Tune: Pressing this key initiates an automatic tuning procedure. The Tune function adjusts and optimizes the voltages applied to the mass spectrometer for peak sensitivity and performance.

NOTE:

*Please refer to section 3.3, **MS-50 Tuning and Calibration**, for a detailed discussion of the **Cal Check** and **Tune** functions.*

Zero

During leak testing, pressing the **Zero** key will cancel out, or “zero”, any leak rate reading. This feature enables MS-50 operators to compensate for the presence of residual helium in the system introduced through the test port or test object. Any time the Zero key is depressed during a leak test, measurement is automatically restricted to two ranges below the displayed leak range.

When **auto-ranging**, the unit will automatically stop **two** decades below the point when the Zero key was depressed; if **manual ranging** is selected, the unit will emit a short beep whenever the user attempts to range more than **two** decades below the point when the Zero key was pressed. The Zero function does not inhibit ranging upward during testing. The Zero function may be used during leak testing only.

Scan

Scan is a test aid the MS-50 operator can use to quickly verify that the unit is operating correctly. During testing, the user can determine whether a leak rate indication is due to the presence helium or is in fact the result of a poorly tuned spectrometer.

By pressing the **Scan** keys, the user temporarily alters the spectrometer peak tuning voltages either -30 or +30 volts from their prior position (releasing either button returns the voltages to their previous condition). If scanning is performed on a unit with an optimally tuned mass spectrometer, the displayed leak rate (due to background helium, helium from a calibrator, or a real leak) will decrease to zero indicating that the measurement is actually due to the presence of helium. If the displayed leak rate does not decrease to zero after either Scan button is pressed, the mass spectrometer is not optimally tuned, and the **Tune** function must be used to retune the mass spectrometer.

Mass Spec

Fil On/Off: Pressing this key will toggle the selected filament (**1** or **2**) on or off. In **Normal** mode, the filament may be turned on whenever the high vacuum is determined by the system computer to be sufficiently low (less than 5×10^{-4} Torr). In Normal mode, the filament cannot be turned off during a test. To turn the filament off, the unit must first be placed in standby (**Ready To Test**) status.

In **Service** mode, the MS-50's safety interlocks are disabled. After turning on the filament in Service mode, it is essential to immediately check that the pressure in the high-vacuum section is below 5×10^{-4} Torr. If the filament is turned on when the high-vacuum section is at or near atmosphere, it will quickly burn out.

Fil 1/2: Toggles between **Filament 1** and **Filament 2**. A green indicator next to the **1** or **2** on this key indicates that the respective filament is working properly. If a red LED appears, the indicated filament is malfunctioning.

Audio

The arrow keys in the **Audio** section of the User Panel adjust the unit speaker (or headphone) volume higher or lower. Pressing **Mute** toggles the audio output on or off.

When leak testing with the **Reject** function (*see 3.4.3*) disabled, and while in **Service** mode, the audio signal is always on. If the Reject function is enabled, the audio signal turns on only when the leak rate is greater than the specified Reject setpoint.

Modes

Sleep: Powers down the MS-50 while maintaining a high vacuum state so that testing may resume immediately upon Power Up. The computer pumps down the test port and the unit crosses over into Direct mode; the filament and rough pump are then turned off, and the CRT screensaver is activated. Sleep Mode is deactivated when the user presses the **[1] Power Up** soft-key.

Figure 3 – 3
Sleep Mode

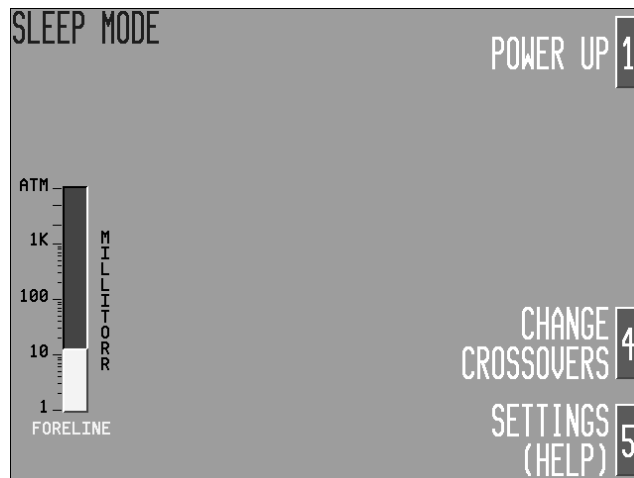

Vac/Sniff: Toggles between Vacuum Testing mode and Sniff Testing mode. Procedures for testing in both modes are explained in the following section, **Leak Detector Operation**.

Ranging

Prior to and during leak testing, the operator may toggle between **Automatic** and **Manual** ranging modes.

When leak testing using Manual ranging, each depression of a ranging “arrow” key increments or decrements the leak range being tested by one decade. The exponent of the leak rate displayed on the CRT will indicate the change.

When leak testing using Automatic ranging, pressing either arrow button places the unit in Manual ranging mode, at a decade higher or lower

(depending on the arrow key pressed) than the decade previously being tested. To return to Automatic ranging, press the **Auto/Manual** button again.

3.1.4 Softkeys [1-5]

The vertically arranged soft-keys (numbered **1 - 5**) correspond to settings and selections that appear on the CRT. By pressing the appropriate soft-key, various menu options are displayed and leak testing parameters can be set and adjusted.

3.1.5 The START/VENT Panel

Start

Pressing the **START** button begins a test cycle. Pressing **START** again after testing has commenced will halt testing by closing all vacuum system valves (except the foreline valve). This action also places the unit into its standby (**Ready to Test**) mode. Pressing **START** instead of **VENT** eliminates the chance of the user inadvertently venting the system (see **VENT** function, below).

Vent

Dual function pushbutton. When pressed momentarily, the MS-50 is interrupted from its current testing cycle and placed in standby (**Ready to Test**) mode. When pressed and held down for a predetermined delay interval (set by the user; the factory default is 1.0 seconds) the MS-50 is automatically vented, returning the test port to atmospheric pressure.

3.1.6 The CRT Display Monitor

The MS-50 display is a 9" color VGA-type cathode ray tube monitor. The CRT draws power from the dedicated AC power plug located at the rear of the MS-50. The CRT connects to the MS-50's computer via a 15-pin HD connector. A row of controls along the bottom front portion of the CRT allow the operator to adjust color, hue, brightness, and vertical/ horizontal screen position. A single-throw switch on the CRT toggles power to the device on or off.

3.2 Leak Detector Operation: Overview

3.2.1 Powering Up the MS-50 Leak Detector

The MS-50 is powered up by pressing the I/O switch on the unit's front panel. During the approximately three-minute start-up sequence, the following steps occur:

1. The CRT displays "Loading System Program. Please Wait"

Figure 3-4
Start Up Screen #1

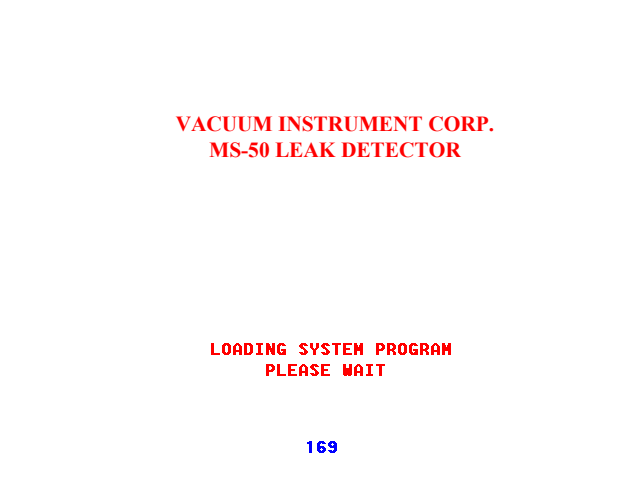

2. The foreline valve opens and the turbo pump is activated. The CRT display appears as below. The Foreline and High Vac bar graph indicators show the MS-50 vacuum system pressure changing as the unit readies itself for testing.

Figure 3-5
Power Up In Progress Screen

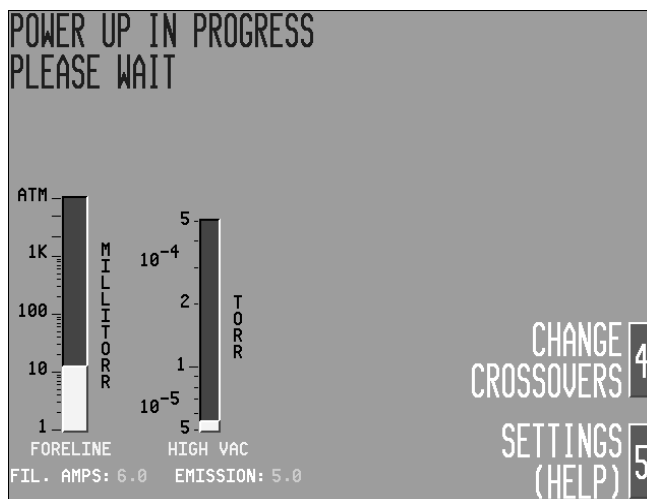

3. When the turbo pump reaches full speed, the **filament** is turned on.
4. The system background and offsets are measured. Once the Hi-Vac pressure drops below 5×10^{-4} std cc/sec air equivalent, the **Ready To Test** screen (below) is displayed, and the MS-50 is ready for use.

Figure 3-6
Ready To Test
Status

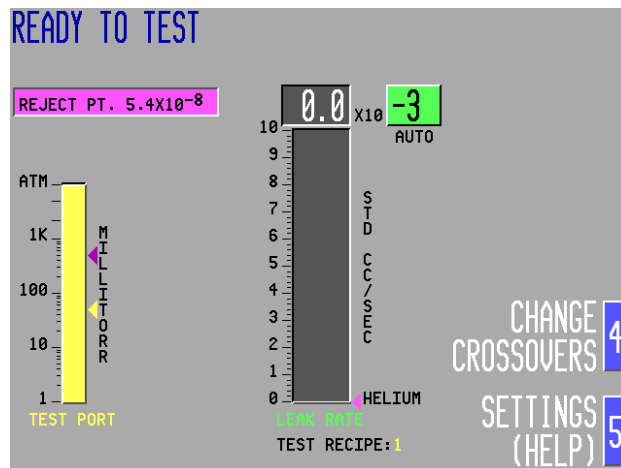

NOTE:

*If the MS-50 is powered down with the filament off, the filament will remain off after the unit is powered up again. In this case, the operator must switch on the filament by pressing either the **Fil On/Off** or the **START** switch. The system computer will prohibit any testing for fifteen seconds after the filament is turned on so that it may acquire accurate system background measurements. During this fifteen second period, the MS-50 will emit an audible "beep" if the **START** switch is pressed. At the end of the fifteen seconds, a test may be commenced by pressing the Start switch.*

3.2.2 Ready To Test (Standby) Mode: CRT Display

Ready To Test when displayed, the unit is in standby mode (all valves except the foreline valve are closed). Pressing the **START** button will commence a test cycle.

Leak Rate

A bar graph that indicates the measured leak rate of the test object. The bar graph display is in **std cc/sec**, **mBar l/sec**, or **Pascal m3 /sec**. **Auto** or **Manual** ranging mode is indicated near the upper right of the bar graph, beneath the **Range** exponent.

Test Port

A bar graph that displays the pressure at the test port. Scaled for either **milliTorr**, **millibar**, or **Pascal**.

Reject Point

During leak testing, this field indicates whether the leak measured is higher (reject) or lower (accept) than a predetermined maximum acceptable leak rate (the **Reject Point**). The Reject setpoint is selected by the user.

3.2.3 Vacuum Leak Testing Modes and Procedures

About Vacuum Testing

Vacuum testing is performed by connecting a test object to the leak detector test port. When **START** is pressed, the unit begins evacuating the test object. Once evacuated, the test object is sprayed with helium gas. If a leak exists, the helium is drawn through the leak in the test object into the MS-50, where it is measured. The size of the leak is displayed on the CRT.

In an alternative method of vacuum testing, the leak detector evacuates a chamber containing a test object pre-filled with helium gas. The MS-50 then measures the helium leaking from the test object into the chamber.

1. **Vacuum Testing:**

Automatic Flow Mode Switching/Auto Ranging (Gross Screening On)

*From the onscreen **Help/Settings Menu** (see section 3.4.1) highlight **Flow Modes**, then press [2] **Change**. From the next screen, select [4] **Reverse and Direct (Combination)**. Press [5] **Exit** leave the settings menus. The MS-50 is now set to **Automatic** flow switching mode.*

*Place the MS-50 into **VAC** mode and **AUTO** ranging (by toggling the corresponding user panel keys, shown at left; green LED's indicate the currently active mode). **Gross Screening** (see 3.4.16) should be toggled **On**. Leak testing proceeds as follows:*

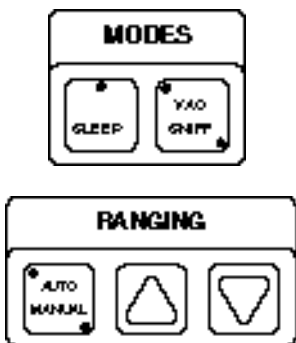

1. Press the **VENT** switch and allow the test port to vent to atmospheric pressure. Remove the plug that covers the test port and connect the test object to the test port.

2. Press the **START** button. The Rough valve opens, and the MS-50 begins evacuating gases from the test object.
3. When the test port pressure reaches its Gross mode crossover setpoint (100 Torr, a fixed value not adjustable by the user), the Gross valve opens. Leak testing begins in the 10^{-3} std cc/sec range. Spraying of the test object with helium should now commence.
4. If a Gross leak is detected, the unit will range up to the appropriate decade, while the test object continues to be pumped down.
5. If no leak is found in the Gross range (0.6×10^{-4} std cc/sec and higher) and the test port pressure has reached the Reverse Crossover setpoint (user specified, 10.0 Torr max) the unit will begin testing in **Reverse** mode. The Gross valves closes and the Reverse valve opens. Following a preset, user-adjustable delay (see **Reverse Rough Close Delay** function, section 3.4.9) the Rough valve closes. The leak detector ranges downward, testing in the 10^{-5} to 10^{-9} std cc/sec ranges.
6. If a leak is still not detected and the test port pressure has reached the Direct Crossover setpoint (user specified, 200 mTorr max), the unit will begin testing in Direct mode; the Reverse valve closes, the **Direct** valve opens following a user-adjustable Direct Crossover Delay (see 3.4 .11) and the unit ranges downward to the 10^{-10} std cc/sec range.
7. The unit will continue to test in this range until a larger leak is found or until the **VENT** button is pressed. If a larger leak is found, the MS-50 will automatically range up to the range of the leak; if the leak exceeds 9.0×10^{-5} , the MS-50 will cross back into Gross testing. Pressing the **VENT** button closes all valves except the Foreline valve. Holding the **VENT** button down for a preset (user-adjustable) duration opens the Vent valve (the test cycle may also be terminated by pressing **START** a second time. This will close all valves except the Foreline valve, without venting the system).

2. Vacuum Testing: Automatic Flow Mode Switching/Manual Ranging

*In this configuration, the system automatically pumps the test port to the lowest pressure obtainable, however, the operator **manually** selects the range in which a leak is suspected. Ranges are selected by pressing the **Ranging** up/down arrow keys to adjust the range higher or lower. Leak testing proceeds as follows:*

1. The leak detector should be in **Ready To Test** status. Press the **Auto/Manual** ranging key to place unit in manual ranging mode (notice that the word **Manual** now appears beneath the green range field on the CRT, above the leak rate bar graph).
2. Select a range in which to begin testing using the ranging up/down adjust keys; each time a ranging adjust key is depressed, the selected testing range increments or decrements one decade. Press and hold the **VENT** button down to vent the test port to atmospheric pressure. Remove the test port plug and connect the test object to the test port.
3. Press the **START** button. The Rough valve opens, and the MS-50 begins evacuating gases from the test object.
4. If a Gross Mode range is selected (ie, 10^{-0} to 10^{-3}) helium spraying can start when the test port pressure drops to 100 Torr (the fixed Gross mode crossover setpoint), and the **Gross** valve opens.
5. If a Gross leak is detected and the leak size is not in the selected range, use the **Ranging** keys to adjust the selected range up or down until the leak is on scale and the precise size of the leak is displayed on the CRT.
6. If the selected range is 10^{-4} to 10^{-9} , the unit will test in Reverse mode. If the selected range is 10^{-10} , the unit will test in Direct mode. The test port is pumped to the appropriate crossover pressure, and leak testing commences in the selected range. As in Gross mode, if a leak is detected and the leak size is not in the selected range, range up or down with the ranging adjust keys until the leak is on scale and the precise size of the leak can be displayed above the leak rate bar graph.
7. The unit will continue to test in the selected range until a leak is found or until the **VENT** button is pressed.

3. Vacuum Testing: Automatic Flow Mode Switching (Gross Screening Off)

*Set test parameters as in **example 1**; in this example, however, **Gross Screening** (see 3.4.16) should be toggled **Off**.*

1. Press and hold the **VENT** button to allow the test port to vent to atmospheric pressure. Remove the test port plug and connect the test object to the test port.
2. Press the **START** button. The Rough valve opens, and the MS-50 begins evacuating gases from the test object.
3. When the test port pressure reaches the Reverse crossover setpoint (user-adjustable, 10,000 mTorr max), the Reverse valve opens and the Rough valve closes. The foreline valve remains open. Spraying of the test object with helium should now commence.
4. Reverse leak testing begins in the 10^{-4} range. If the leak rate exceeds 9.0×10^{-4} , the unit will cross back into **Gross** mode; otherwise, the MS-50 will begin ranging downward to the level of the leak. If no leak larger than 0.6×10^{-9} is found, the test port pressure is checked to determine if the unit may crossover into **Direct** mode.
5. When the test port pressure reaches the Direct mode crossover set point (200 mTorr max), the leak detector crosses over to the Direct flow mode; the **Direct** valve opens and, following a user-adjustable delay period, the **Reverse** valve closes. The unit will now range down to the 10^{-10} range.
6. The unit will continue to test in this range until a larger leak is found or until the **VENT** button is pressed. If a larger leak is found, the MS-50 will automatically range up to the range of the leak. If the leak rate exceeds 9.0×10^{-5} , the unit will cross back into Gross testing. Pressing the **VENT** button closes all valves except the Foreline valve. Holding the **VENT** button down for a preset (user-adjustable) period of time opens the Vent valve (the test cycle may also be terminated by pressing **START** a second time. This will close all valves except the Foreline valve, without venting the system).

4. Vacuum Testing:

MS-50 Locked into Direct Flow Mode (Gross Screening On)

To lock the MS-50 into Direct Flow mode, select **Flow Modes** from the **Help/Settings Menu** (fig 3-10), and press [2] **Change**. From the screen that follows (fig 3-26), select [3] **Direct Flow Mode Only**. Return to **Ready to Test** status by pressing [5] **Exit**. **Gross Screening** (see 3.4.16) should be toggled **On**.

1. Press and hold the **VENT** button to allow the test port to vent to atmospheric pressure. Remove the test port plug and connect the test object to the test port.
2. Press the **START** button. The Rough valve opens, and the MS-50 begins evacuating gases from the test object.
3. When the test port pressure reaches the Gross mode crossover setpoint (100 Torr, a fixed value not adjustable by the user) the Gross valve opens.
4. Leak testing begins in the 10^{-3} range. Spraying of the test object with helium should now commence.
5. If a leak larger than 9.0×10^{-3} is found, the unit ranges up to the appropriate decade. If the leak rate is less than 0.6×10^{-3} , the unit ranges down to the 10^{-4} range. If the leak rate is less than 0.6×10^{-4} , the unit checks test port pressure to determine if it may crossover into Direct flow mode.
6. If the test port pressure is less than or equal to the Direct crossover set point (200 mTorr max), the leak detector crosses over to Direct flow mode (following user-adjustable **Direct XOver Delay**; see 3.4.11) and ranges down to the 10^{-5} range. The Direct valve opens. Following a preset delay (the **Direct Rough Close Delay**, user-adjustable; see 3.4.10), the Gross and Rough valves close (the foreline valve remains open).
7. Leak testing continues as the unit ranges down to the 10^{-10} range. The unit will continue to test in this range until a larger leak is found or until the **VENT** button is pressed. If a larger leak is found, the MS-50 will automatically range up to the range of the leak. If the leak rate exceeds 9.0×10^{-5} , the unit will cross back into Gross leak testing mode.

Pressing the **VENT** button closes all valves except the Foreline valve. Holding the **VENT** button down for a preset (user-adjustable) period of time opens the Vent valve (the test cycle may also be terminated by pressing **START** a second time. This will close all valves except the Foreline valve, without venting the system).

5. Vacuum Testing:

MS-50 Locked into Direct Mode (Gross Screening Off)

*Set test parameters as in example 4; in this example, however, **Gross Screening** (see 3.4.16) should be toggled **Off**.*

1. Press and hold the **VENT** button to allow the test port to vent to atmospheric pressure. Remove the test port plug and connect the test object to the test port.
2. Press the **START** button. The Rough valve opens, and the MS-50 begins evacuating gases from the test object.
3. When test port pressure reaches the **Direct** crossover setpoint (user-adjustable, 200 mTorr max), the Direct valve opens (following a user-adjustable **Direct XOver Delay** - see 3.4.11). The Rough valve closes (after a user-adjustable **Direct Rough Close Delay** - see 3.4.10). The Foreline valve remains open.
4. Leak testing begins in the 10^{-5} range. Spraying of the test object with helium should now commence. If the leak rate exceeds 9.0×10^{-5} , the unit will cross back into **Gross** test mode. Otherwise, the MS-50 ranges down to the 10^{-10} range, stopping if a leak is located in a particular range.
5. Leak testing continues as the unit ranges down to the 10^{-10} range. The unit will continue to test in this range until a leak is found or until the **VENT** button is pressed.

If a larger leak is found, the MS-50 will automatically range up to the range of the leak. If the leak rate exceeds 9.0×10^{-5} , the unit will cross back into Gross leak testing mode. Pressing the **VENT** button closes all valves except the Foreline valve. Holding the **VENT** button down for a preset (user-adjustable) period of time opens the **Vent** valve. The test cycle may also be terminated by pressing **START** a second time. This will close all valves except the Foreline valve, without venting the system).

6. Vacuum Testing:

MS-50 Locked into Reverse Flow Mode (Gross Screening On)

To lock the MS-50 into Reverse Flow mode, select **Flow Modes** from the **Help/Settings Menu** (fig. 3-10), and press [2] **Change**. From the screen that follows (fig. 3-26), select [2] **Reverse Flow Mode Only**. Return to **Ready to Test** status by pressing [5] **Exit**. **Gross Screening** (see 3.4.16) should be toggled **On**.

1. Press and hold the **VENT** button to allow the test port to vent to atmospheric pressure. Remove the test port plug and connect the test object to the test port.
2. Press the **START** button. The Rough valve opens, and the MS-50 begins evacuating gases from the test object. When the test port pressure reaches its Gross Mode Crossover setpoint (100 Torr, a fixed value not adjustable by the user) the Gross valve opens.
3. Leak testing begins in the 10×10^{-3} std cc/sec range. Spraying of the test object with helium should now commence.
4. If a Gross leak is detected, the unit will range up to the appropriate decade, while the test object continues to be pumped down.
5. If no leak is found in the Gross range (0.6×10^{-4} std cc/sec and higher) and the test port pressure has reached the Reverse crossover setpoint (user adjustable, 10.0 Torr max) the unit will begin testing in **Reverse** mode. The Gross valves closes and the Reverse valve opens. Following a preset delay (**Reverse Rough Close Delay**, user-adjustable; see 3.4.9) the Rough valve closes, and the leak detector ranges downward to the 10^{-9} std cc/sec range.
6. The unit will continue to test in this range until a larger leak is found or until the **VENT** button is pressed. If a larger leak is found, the MS-50 will automatically range up to the range of the leak. If the leak rate exceeds 9.0×10^{-4} , the unit will cross back into Gross leak testing mode. Pressing the **VENT** button closes all valves except the Foreline valve. Holding the **VENT** button down for a preset (user-adjustable) period of time opens the **Vent** valve (the test cycle may also be terminated by pressing **START** a second time. This will close all valves except the Foreline valve, without venting the system).

7. Vacuum Testing:

MS-50 Locked into Reverse Mode (Gross Screening Off)

Set test parameters as in *example 6*; in this example, however, **Gross Screening** (see 3.4.16) should be toggled **Off**.

1. Press and hold the **VENT** button to allow the test port to vent to atmospheric pressure. Remove the test port plug and connect the test object to the test port.
2. Press the **START** button. The **Rough** valve opens, and the MS-50 begins evacuating gases from the test object.
3. When the test port pressure reaches the Reverse mode crossover setpoint (user adjustable, 10 Torr max), the **Reverse** valve opens. After a preset delay (**Reverse Rough Close Delay**, user-adjustable; see 3.4.9) the Rough valve closes. The Foreline valve remains open.
4. Leak testing begins in the 10^{-4} range. If the leak rate exceeds 9.0×10^{-4} , the unit crosses back into Gross test mode. Otherwise, the MS-50 ranges down to the 10^{-9} range, stopping if a leak is found in a particular range.
5. The unit will continue to test in this range until a larger leak is found or until the **VENT** button is pressed. If a larger leak is found, the MS-50 will automatically range up to the range of the leak. If the leak rate exceeds 9.0×10^{-5} , the unit will cross back into Gross leak testing mode.

Pressing the **VENT** button closes all valves except the Foreline valve. Holding the **VENT** button down for a preset (user adjustable) period of time opens the Vent valve (the test cycle may also be terminated by pressing **START** a second time. This will close all valves except the Foreline valve, without venting the system).

3.2.4 Sniff Testing

Sniff Testing is performed by checking for escaping helium in a test object already filled with helium gas. Sniff testing differs from vacuum testing in that:

- Sniff testing is **qualitative** rather than **quantitative**.
- Leak detection is performed through a **Sniff Probe** (VIC P/N 0139-045-00) attached to the test port.
- The test object itself is not evacuated during testing.

By passing the sniffer probe over a suspected leak, out flowing helium from the test object is drawn into and measured by the system. This type of testing is most useful when testing large objects (large tanks, for example) or when testing items that cannot withstand internal vacuum.

Sniff testing is the least sensitive test the MS-50 performs (a sniffer probe ultimately draws in some surrounding air, which acts to dilute the helium leak tracer), and it is best used for *locating* leaks rather than measuring them.

The procedure for Sniff Testing is as follows:

1. Prior to attaching the Sniffer probe, the MS-50 should be in standby (**Ready To Test**) status, and the test port should be vented to atmospheric pressure.
2. After venting, attach the Sniffer probe to the test port.
3. From the User Panel **MODES** keys, toggle **Sniff** mode on (a green LED indicates whether the unit is in **VAC** or **SNIFF** mode). The CRT will display the message “**Ready To Sniff.**”

4. Press the Auto/Manual **RANGING** key to select either Automatic or Manual ranging. If Manual ranging is selected, set the anticipated leak rate range using the **RANGING** “arrow” keys (in either ranging mode, the unit will be able to test leaks within the 10^{-2} to 10^{-7} std cc/sec range).
5. Press the **START** button. The CRT will display the message “**Sniff Testing.**” Using the probe, examine the surface of the test object for leaks.

NOTE:

*If the unit is set for Automatic ranging, it will range down to the level of the ambient helium (the low 10^{-6} or 10^{-7} range) when **START** is pressed. This background helium level may be subtracted from the measurement by pressing the **ZERO** button (“zeroing out”).*

NOTE:

*If the keyswitch is in **Set** position during Sniff testing, the **Amp Gains** keys can be used to adjust the Sniff Gain (**G4**). For additional information on using the Gains settings, refer to **Chapter Four: Service and Maintenance**.*

6. When Sniff testing is complete, press and hold down **VENT** button. Remove the Sniff Probe assembly from the test port and replug. Pressing the **Vac/Sniff** mode button once returns the MS-50 to **Ready To Test** status.

3.3 MS-50 Tuning and Calibration

The MS-50 is automatically tuned and calibrated for Helium 4 using a factory-installed temperature compensated Helium 4 standard (traceable to NIST) as a reference. During tuning, the MS-50's computer controls the vacuum system valves and adjusts the various voltages of the mass spectrometer to obtain an optimum response to the helium signal from the reference standard. After the voltages are optimized, the gains of the amplifier are adjusted until the displayed leak rate value corresponds to the temperature compensated value of the helium standard.

3.3.1 Tune

Tuning is initiated by pressing the TUNE button (one of the two System keys on the User Panel).

Tuning is a **fully automatic** function controlled by the system computer. A complete tune cycle lasts approximately seven (7) minutes. During this time, the vacuum system is measured and compensated for background, the mass spectrometer voltages are optimized for maximum sensitivity, and the system gains for Reverse (**G2**) and Direct (**G3**) modes are set. At the end of the Tune sequence, the MS-50 is fully tuned and calibrated.

Tuning may be halted at any time by pressing [3] **Abort Auto Tune**.

Figure 3 – 7
Automatic
Tuning

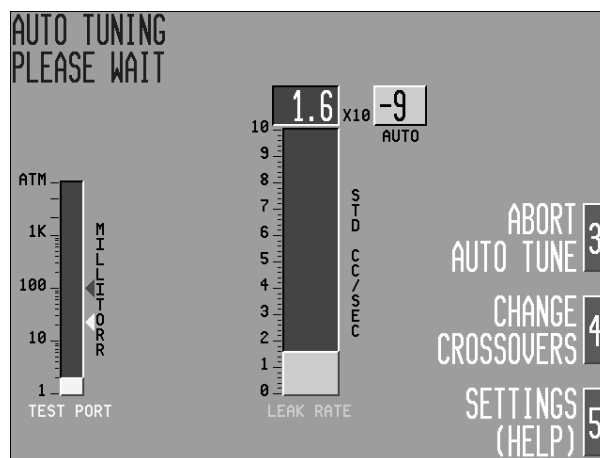

3.3.1.1 Auto Tune Alert

The Auto Tune Alert feature reminds the user to Auto Tune the leak detector every 50 hours, or whenever system gains G2 and/or G3 rise above 7.5. When an Auto Tune Alert condition exists, the MS-50 displays the screen shown in figure 3-7.1.

If the Auto Tune Alert is triggered by the end of a 50 hour interval, the user should Auto Tune the leak detector by depressing the TUNE key on the user panel).

If, upon conclusion of an Auto Tune or a Calibration cycle, system gains G2 and/or G3 exceed 7.5, the Auto Tune Alert will again appear. In this circumstance, the user cannot continue testing without first performing an additional Auto Tune. The leak detector will “beep” until the Auto Tune is initiated.

If system gains of greater than 7.5 persist after the second Auto Tune, the Auto Tune Alert reappears. This is a possible indication that the leak detector’s mass spectrometer has become contaminated and needs to be cleaned. It may also be caused by a failure of either the mass spectrometer source or collector, in which case the failed component should be replaced (see Chapter Four, Service and Maintenance).

NOTE: If for some reason you wish to continue testing after an Auto Tune Alert appears, you may press the ZERO button on the user panel. This resets the 50 hour alert timer to 0.0 hours; the alert will not be displayed again until another 50 hours have elapsed.

Figure 3–7.1
Auto Tune Alert

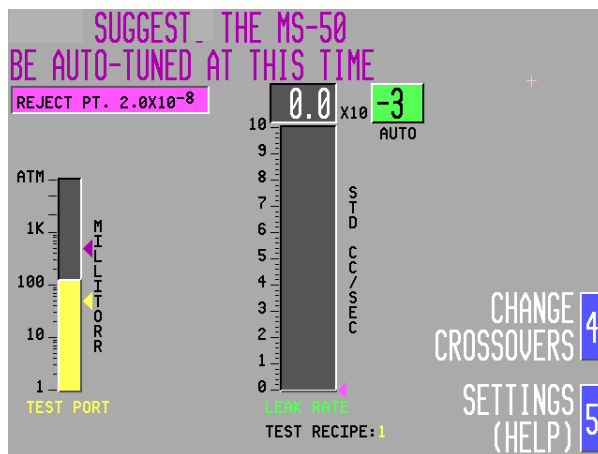

3.3.1.2 Automatic Auto Tune

When Automatic Auto Tune is enabled, the leak detector will automatically Auto Tune each time it is powered-up. Once the Auto Tune is completed, testing may commence. If a user finds it necessary to bypass the Auto Tune procedure, pressing the TUNE button on the user panel at any time during the Auto Tune cycle will terminate the Auto Tune.

NOTE: If desired, the Auto Tune Alert and/or Automatic Auto Tune functions may be bypassed by reconfiguring the settings to profile switches SW1 and SW2, located on Circuit Board A. To assure optimum system performance, we recommend that users not alter the factory default settings.

Figure 3-7.2 indicates the proper switch configuration for various options.

**Figure 3-7.2
Profile Switch
Settings**

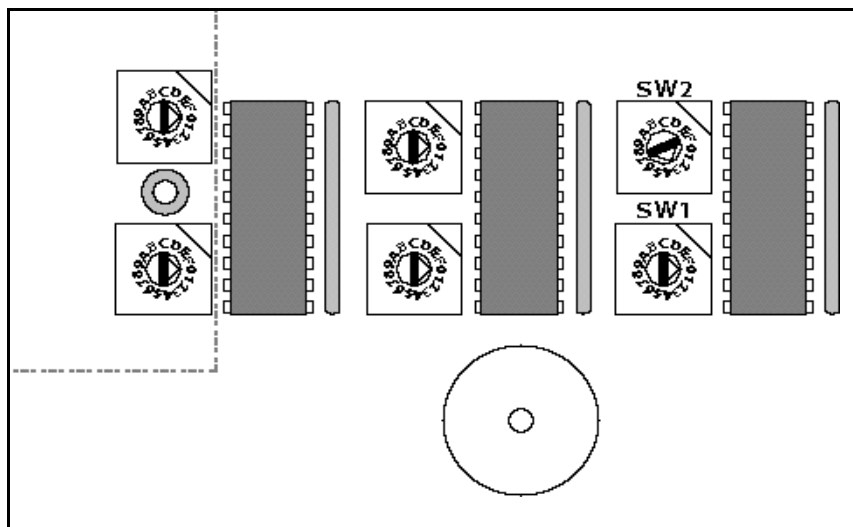

	SW1	SW2	
▪ Auto Tune Alert & Auto Tune Enabled	0	3	(Default Setting)
▪ Auto Tune Alert & Auto Tune Disabled	0	0	
▪ Auto Tune Alert Enabled ONLY	0	1	
▪ Automatic Auto Tune Enabled ONLY	0	2	

WARNING!

The MS-50 should be turned OFF before attempting to change profile switch settings. When the unit is powered ON, potentially lethal high voltages are continually applied to the circuit boards and other areas within the unit. Failure to follow this precaution may lead to severe injury or death.

3.3.2 Cal Check

Pressing the CALCHECK button initiates a Calibration Check sequence using the MS-50's internal leak rate standard (calibrator).

Cal Check is used to verify the measurement accuracy of the MS-50 leak detector. During a Cal Check, the unit automatically measures and subtracts system background, then measures the internal leak rate standard (calibrator).

Figure 3-8
Cal Check
Screen 1

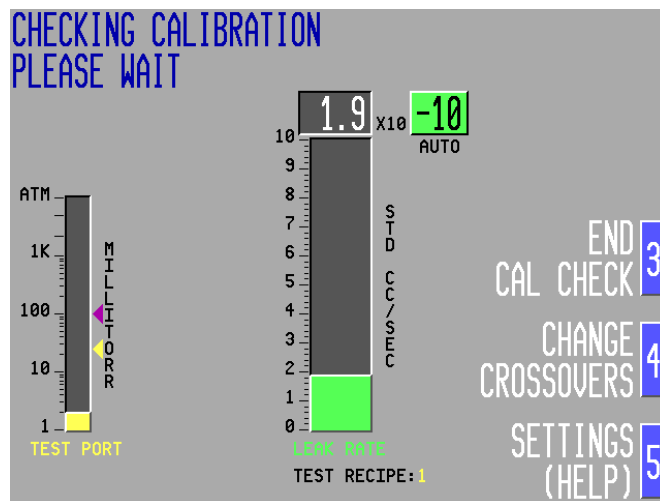

When the Cal Check sequence is completed, the CRT will indicate the results in the upper left corner of the display (for example: “LEAK RATE SHOULD READ: 1.6×10^{-8} ”).

The measured, or actual, reading of the internal standard on the **Leak Rate** bar graph should then be compared to the “**Leak Rate Should Read**” value, which indicates the calculated leak rate of the internal calibrator at the current temperature. The unit is considered to be measuring accurately whenever the two readings are within 10% of each other.

If the readings are within 10% of each other, press [3] **End Cal Check** to end the sequence and return to the previous screen.

Figure 3-9
Cal Check
Screen 2

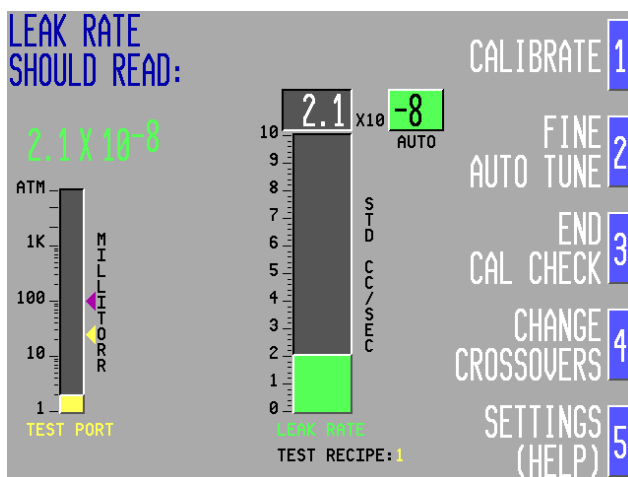

NOTE:

Pressing either [3] **End Cal Check** or the **Cal Check** User Panel key at **any** time during the Cal Check sequence will abort the Cal Check.

To quickly compensate for a minor (approximately 10 to 15 percent) discrepancy between the readings, press [1] **Calibrate**. This will instantaneously adjust the **G2** and **G3** gain settings to calibrate the unit. Press [3] **End Cal Check** to end the calibration.

If a discrepancy larger than 15 percent is observed, press [2] **Fine Auto Tune**. The Fine Auto Tune procedure takes approximately two to three minutes to complete. Following a Fine Auto Tune, a second Cal Check should be performed. If the Cal Check indicates the MS-50 is still not properly tuned and calibrated, a full **Auto Tune** (as in 3.3.1) should be performed (*Fine Auto Tune only adjusts the mass spectrometer peak voltage within a relatively small window. In cases where the anode voltage is significantly (8 volts or more) away from the peak, it is not effective*).

3.3.3 Calibration Procedure for Helium 3 Testable Masses

The MS-50 is calibrated automatically using an internal leak rate standard for Helium 4 testable masses. Calibration for Helium 3 testable masses is manual and requires the use of an external calibrator connected to the test port. The unit should be set to **He3** (see 3.4.22) prior to calibration.

3.3.4 Using the SCAN Function

Another method of checking system tuning is the **Scan** function. Scanning allows a user to quickly ascertain whether the leak rate indication is due to the presence of helium is in fact the result of a poorly tuned spectrometer.

To use the Scan function while the MS-50 is in leak test mode, press and hold either of the **SCAN** buttons on the User Panel. Pressing the “up” arrow button will alter the spectrometer peak tuning voltage by +30 volts; pressing the “down” arrow button will alter the voltage by -30 volts. Releasing either button returns the spectrometer voltage back to its normal level.

When this test is performed on an optimally tuned spectrometer, the displayed leak rate (due to either background helium or helium from a leak) will decrease to zero, indicating that the measurement is actually due to the presence of helium. Both **SCAN** buttons should be used for this test.

If the displayed leak rate does not decrease to zero after either **SCAN** button is pressed, the spectrometer is not tuned; the **TUNE** function must be used to retune the mass spectrometer.

3.3.5 Gross Mode Calibration

Gross mode calibration covers the range between 10×100 std cc/sec to 0.6×10^{-4} std cc/sec. An external calibrator (a Vacuum Instrument **GL2** type calibrator is recommended) is required for this procedure. Gross mode calibration is performed manually.

1. Place the MS-50 is in **Vac** mode, with the keyswitch on **Set**.
2. Set the MS-50 to manual ranging on the 10^{-3} range. Install the GL2 calibrator in the Test Port.
3. Press **START**. Allow the MS-50 to pump down and begin leak testing.
4. Apply helium to the GL2 at the pressure indicated on the GL2 (5-7 psi); allow the leak rate to stabilize.
5. Using the Amp Gain up/down arrows, adjust the Gross Mode gain setting (**G1**) to calibrate to the GL2.
6. Turn off the helium and press **VENT**.

3.4 Setting Test Parameters

This section describes how to use the MS-50 onscreen menus to select and adjust the leak detector’s user-controllable functions, and how to create and save customized sets of parameters (called test “recipes”) for specific leak testing applications.

3.4.1 The Help/Settings Menu

The Help/Settings Menu (fig. 3-10, left) lists each of the MS-50’s adjustable test parameters and system settings for the currently selected Test Recipe. To set or change parameters, place the unit into Set mode by turning the front panel keyswitch to the left position. The Help/Settings Menu is then accessed by pressing [5] Settings (Help) from the Ready to Test or Leak Testing screen.

NOTE: Test parameters may be viewed, but not altered, while the MS-50 is in Norm mode. If the user attempts to make changes to the settings while Norm mode is selected, a warning “beep” will sound.

Use the [3] Select Up or [4] Select Down softkeys to highlight any parameter, then press [2] Change. By selecting from various onscreen options, test parameters and system settings are easily configured. The current status of the selected parameter is displayed at the top left corner of the CRT screen.

Figure 3-10

Left:
Help /Settings
Menu

Right:
Select Test Recipe
Menu

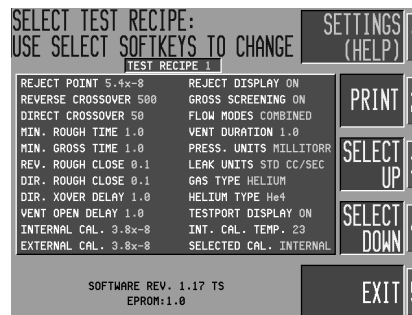
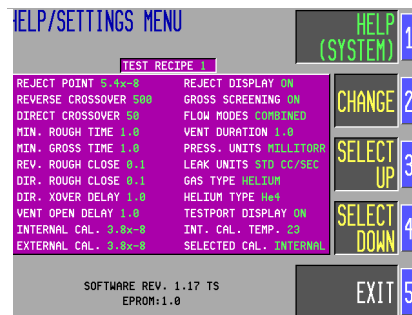

To return to the Help/Settings menu, press [1]. Pressing [5] Leave Menu will return you to the previous operational status screen (ie, Ready to Test or Leak Testing)

.3.4.2 Storing Test Recipes

The MS-50 can store up to 50 separate configurations of test parameters.

These "recipes" may later be retrieved by the operator for specific applications, considerably streamlining the testing process.

To store or make changes to a test recipe, use the Select Up/Down softkeys to highlight the Test Recipe [#] item (at the top of the Help/Settings menu) then press [2] Change to access Select Test Recipe menu (fig 3-10, right).

Use the Select Up/Down softkeys to increment or decrement the displayed test recipe number. Changes made to test parameters while a particular recipe is displayed are stored with that recipe until changed again by the user. Use the [2] Print softkey to send a copy of the currently displayed test recipe to the printer port. To return to the Settings menu, press [5] **Exit**.

3.4.3 Reject Point

The Reject Point determines whether or not the leak rate of the test object meets a predefined maximum leak rate standard. For example, if the Reject Point has been set to 5.0×10^{-5} std cc/sec, any test object that has a leak rate less than 5.0×10^{-5} std cc/sec would fall below the setpoint and therefore into the Accept range. The MS-50 indicates this condition by displaying a green Accept field on the CRT. Likewise, any test object that has a leak rate greater than or equal to 5.0×10^{-5} std cc/sec would fall into the predefined Reject leak rate area. In this instance, the CRT would display a red Reject field.

The default value for the Reject point is 2.0×10^{-8} . Use the [3] Increase or [4] Decrease softkeys to change the Reject point. The Reject On/Off screen may be accessed by pressing softkey [2].

NOTE:

When the Reject display is toggled On, the Reject point also sets a threshold for the unit's Audio monitoring function (see 3.1.4, Audio Keys).

Figure 3-11
Leak Testing
Reject/Accept
Indicators

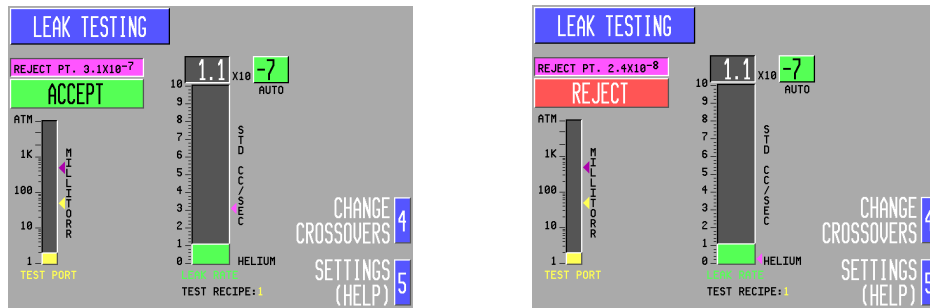
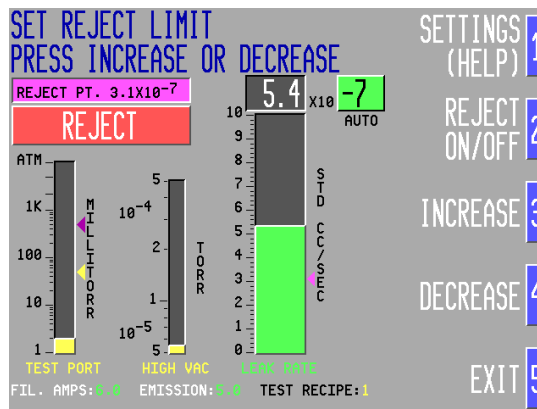

Figure 3-12
Setting the Reject Point



3.4.4 Reverse Crossover

Crossover Select the test port pressure (10,000 mTorr maximum) at which the unit switches into Reverse mode testing. The default Reverse mode crossover setpoint is 500 mTorr. If reverse crossover produces a foreline pressure burst higher than 7000 mTorr, the test cycle will be interrupted. At 8500 mTorr, the system will shut down.

Although high vacuum pressure bursts are unlikely to occur in the Reverse Flow mode, care should still be taken to prevent the foreline pressure from exceeding allowable limits (the usual result of a high crossover in Reverse mode is a temporary increase in background levels)

Figure 3-13
Set Reverse
Crossover

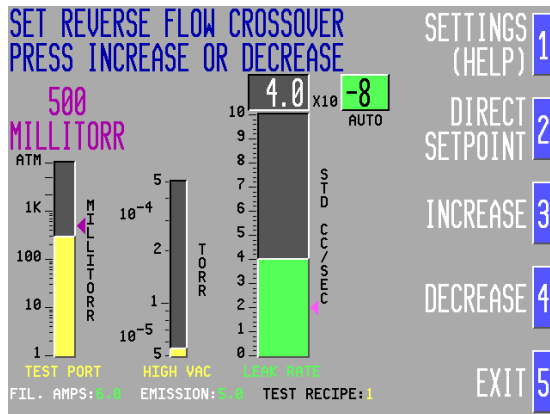

3.4.5 Direct Crossover

Select the test port pressure (200 mTorr maximum) at which the unit switches into Direct mode testing. Adjustable to or less (the default value is 50 mTorr). If crossover produces a pressure burst higher than 5.0×10^{-4} Torr, the test cycle will be interrupted and the filament will automatically turn off. After 15 seconds, the unit will check whether or not pressure has stabilized by momentarily turning the filament on; if pressure has stabilized, the filament will be remain on.

To determine the optimum Direct Flow Mode crossover pressure for a particular test object, it is suggested that the crossover point be set to 20 mTorr and tested. The crossover point should subsequently be increased to minimize the pump down time or decreased to minimize the hi-vac burst.

NOTE: The Hi-Vac pressure bar graph is displayed in the Change Crossover, Power Up and Sleep mode screens; it is not displayed as part of the normal Leak Testing screen.

Figure 3-14
Set Direct
Crossover

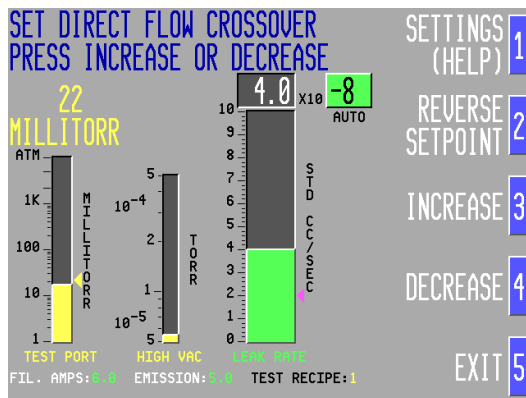

3.4.6 Min Rough Time

Set a minimum duration (in seconds) for rough pump down cycle. The default minimum roughing time is one second. Increasing the roughing time allows more time to pump down the test object and minimizes the possibility of a pressure burst at crossover, particularly when testing parts with a high degree of outgassing.

3.4.7 Min Gross Time

**Figure 3-15
Set Minimum
Roughing Time**

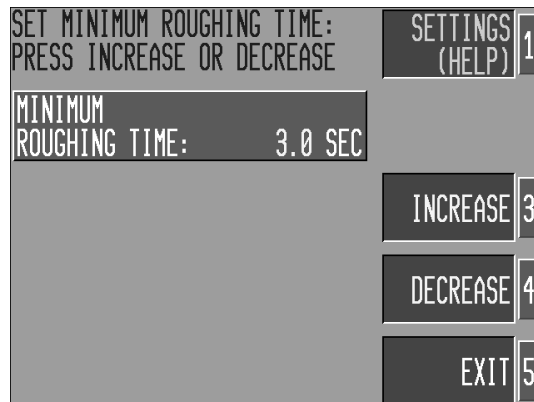

Set a minimum duration (in seconds) for Gross leak testing. The default Gross test time is one second. Increasing the minimum Gross test time allows the operator more time to spray the test object with helium (during an auto-ranging test with Gross Screening on).

**Figure 3-16
Set Minimum
Gross Test Time**

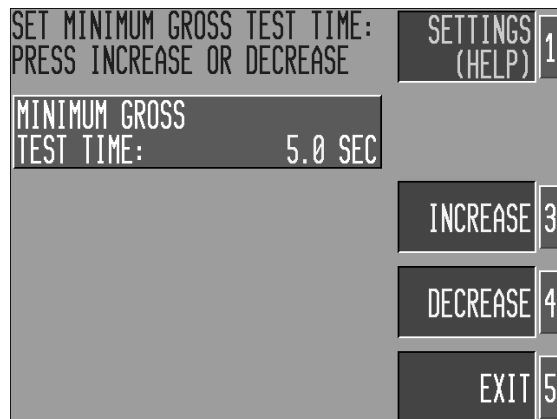

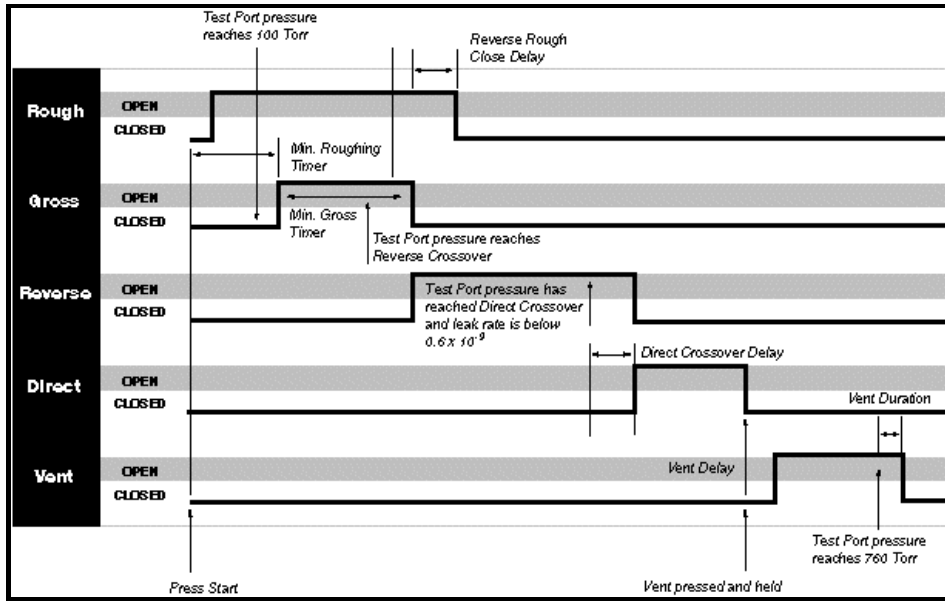

Figure 3-17 MS-50 Valve Timing

MS-50 set to direct & Reverse Flow (Combination) Mode, Gross Screening On, Auto Ranging

Note:

Direct Rough Close Delay is not shown (used when the MS-50 is set for direct flow only: similar to **Reverse Rough Close Delay**)

3.4.8 Delay Settings (Valve Timing Settings)

The MS-50 operator can specify time intervals between the opening and closing of certain vacuum system valves. This allows the user to customize testing cycles to the unique requirements of any test object. In order to properly optimize testing procedures, we recommend that operators review the second chapter of this manual, Theory of Operation, prior to altering the default valve timing settings.

The Valve Timing Schematic (fig. 3-17) illustrates the relationship between the opening and closing of the internal vacuum system valves. Also displayed in the schematic are the user-adjustable time delays of the rough, fine and vent valves and how they impact the test cycle. Descriptions of how delay settings may be used to benefit certain testing conditions are described below.

3.4.9 Reverse Rough Close

Sets the Reverse Rough valve close delay (the amount of time (in seconds) that the Rough valve remains open after the Reverse valve opens - the Rough valve must be closed before Reverse flow testing may occur). The default setting is 0.1 second; the delay may be set to any value between 0.1 and 999.9 seconds. Reverse Rough Close Delay allows the Rough pump to continue pumping the test object after the Reverse valve opens and minimizes any pressure burst that may occur. This function is most useful when test objects are particularly large or exhibit a high rate of outgassing.

Figure 3-18
Set Reverse Mode
Rough Valve Close
Delay

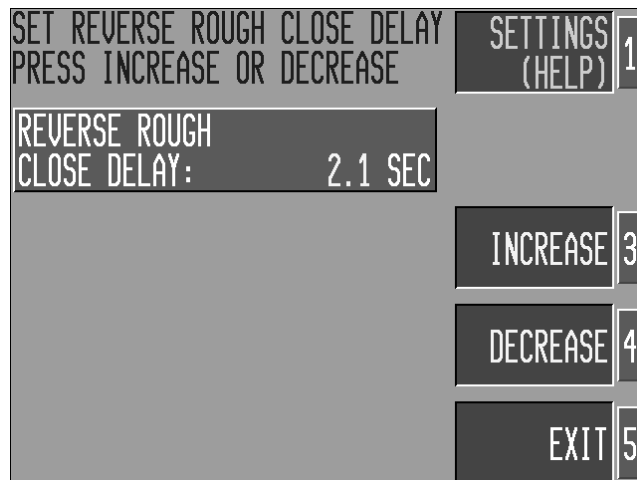

3.4.10 Dir Rough Close

The amount of time (in seconds) the Rough valve remains open after the Direct valve opens (the Rough valve must be closed before Direct testing may occur). The default setting is 0.1 second; the delay may be set between 0.1 and 999.9 seconds. If a test object has a large volume, or the test material exhibits a high rate of outgassing, it can be helpful to increase this delay limit in order to limit the pressure burst that occurs at crossover.

Figure 3-19
Set Direct Rough
Close Delay

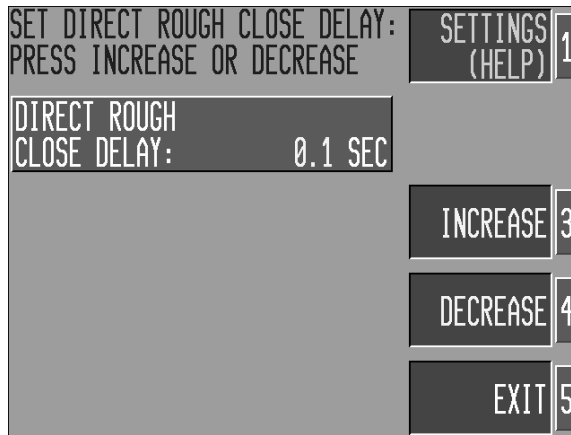

3.4.11 Dir XOver Delay (Direct Crossover Delay)

Refers to the length of time that the Direct valve remains closed after Direct crossover pressure has been attained. The default delay duration is one (1) second; the delay may be set between 0.1 and 999.9 seconds. The ability to delay the Direct crossover is useful for testing objects greater than one liter, or when the test object has a high outgassing rate. The additional rough pumping of a test object prior to opening the Direct valve reduces the possibility of a large Hi-Vac pressure burst at crossover, and limits the chance of burning out the mass spectrometer filament.

Figure 3-20
Set Direct Crossover
Delay

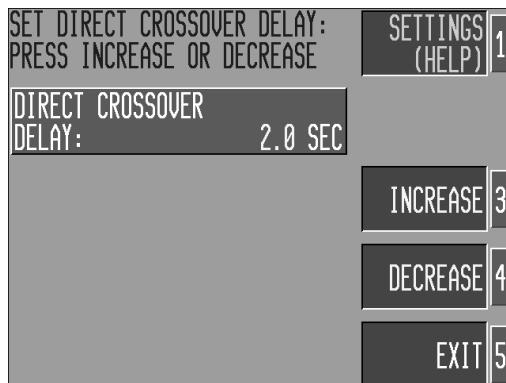

3.4.12 Vent Open Delay

Refers to the length of time (in seconds) between the moment the MS-50 operator presses the VENT button and the actual venting of the unit. Setting a vent delay is useful in preventing accidental venting of the system. The delay may set between 0.1 and 999.9 seconds; the default value is one (1) second.

Figure 3-21
Set Vent Open
Delay

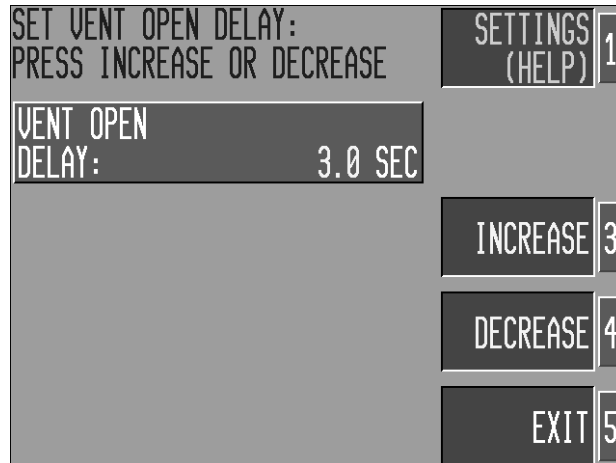

3.4.13 Internal Cal

To set the Internal Calibrator value, press [3] Increase or [4] Decrease until the value displayed onscreen matches the value stamped on the internal leak rate standard. The calibrator value is preset at the factory prior to shipment. It should only be changed if the calibrator has been re-calibrated. Changing this value in any test recipe changes the value for all recipes (since the same calibrator is used regardless of the recipe selected). Pressing [2] Set Calib. Temp accesses the Calibrator Temperature screen (see 3.4.24).

3.4.14 External Cal

To set an External Calibrator value, press [3] Increase or [4] Decrease until the value displayed onscreen matches the value stamped on the external leak standard. The default value is 1.4×10^{-8} std cc/sec air equivalent. A different External Cal value may be programmed for each test recipe.

NOTE:

When using an external calibrator, temperature compensation of the external leak standard is not provided

Figure 3-22

Set Internal Calibrator Value (Left)

Set External Calibrator Value (Right)

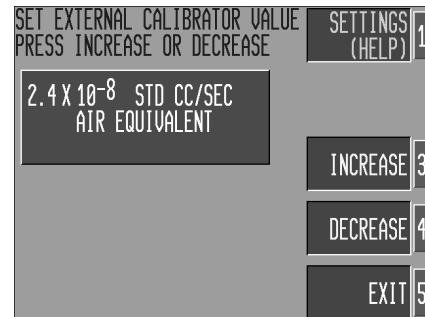
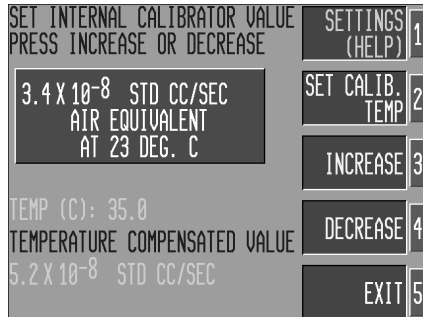

3.4.15 Reject Display

Toggle Accept/Reject field display on or off by pressing [2] Reject On/Off. Adjust the Reject setpoint value by pressing the [3] Increase or [4] Decrease softkeys. The default Reject Display status is on.

NOTE:

When the Reject display is toggled on, the Reject Point sets a threshold for the audio monitoring function (see 3.1.4).

Figure 2-23 Toggle Reject/Accept Delay On/Off

(Left = Off)
(Right = On)

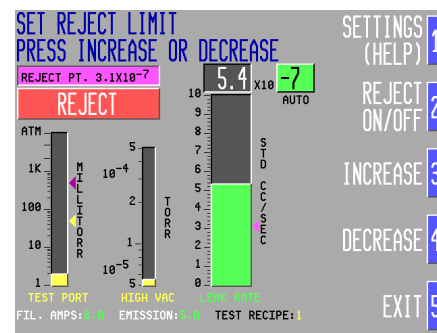
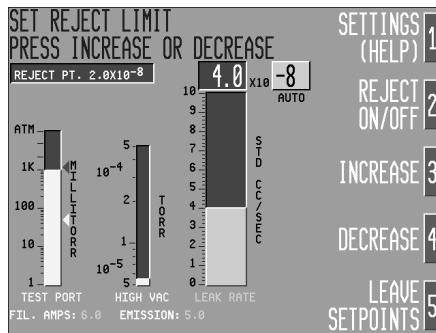

3.4.16 Gross Screening

Enable/Disable the Gross Screening function. When START is pressed with Gross Screening enabled and auto ranging selected, the MS-50 will first check for leaks in the Gross ranges before switching into Reverse or Direct flow mode. The default Gross Screening mode setting is **on**.

Figure 3-24
Enable/Disable
Gross Screening

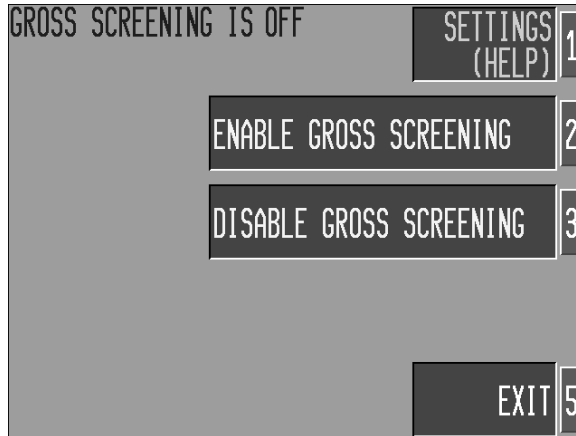

3.4.17 Flow Modes

Select [2] Reverse Flow Mode Only to lock the MS-50 into Reverse mode, [3] Direct Flow Mode Only to lock into Direct mode or [4] Reverse and Direct (Combination) to allow automatic flow mode switching (the MS-50 default mode; refer to 2.2 for an overview of the different flow modes).

Figure 3-25
Select Flow Mode

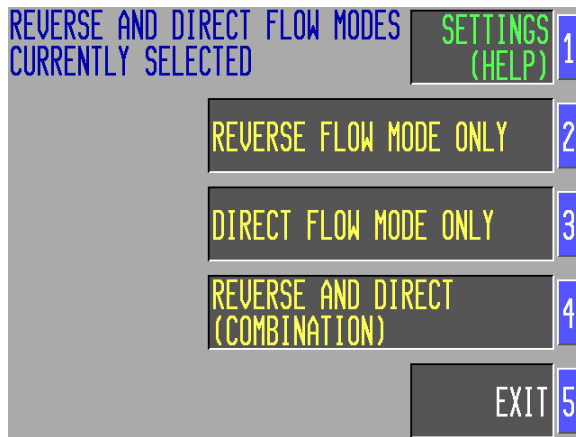

3.4.18 Vent Duration

Set a duration (in seconds) for the Vent valve to remain open after the test port pressure has reached atmospheric pressure. Vent Duration may be adjusted to between 0.1 and 999.9 seconds in order to optimize the venting of any test object. The default setting is one (1) second.

NOTE: If the START button is pressed while the vent valve is open, the vent valve will immediately close.

Figure 3-26
Set Vent
Duration

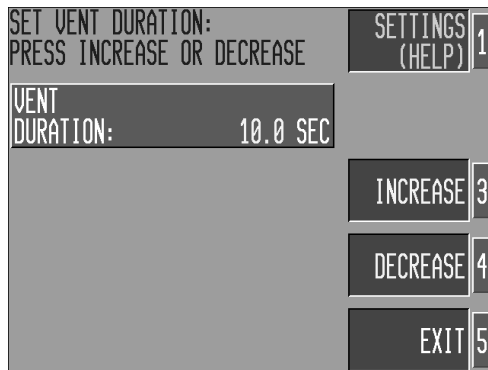

3.4.19 Press. Units

Select a unit of pressure measurement (mTorr, mBar, or Pascal) to be used for onscreen measurement display and test settings.

3.4.20 Leak Units

Select a unit of leak measurement (std cc/sec, Pascal M3/ sec, or Millibar liter/sec) to be used for onscreen measurement display and test settings.

Figure 3-27
Left:
Select Unit of Pressure
Display

Right:
Select Leak Rate Unit
Display

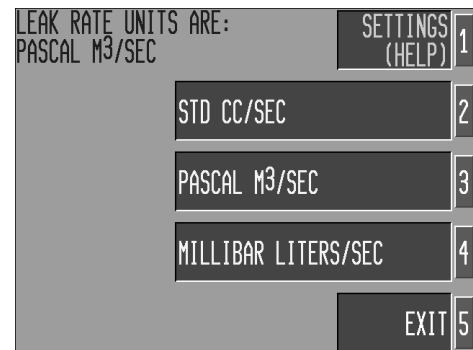
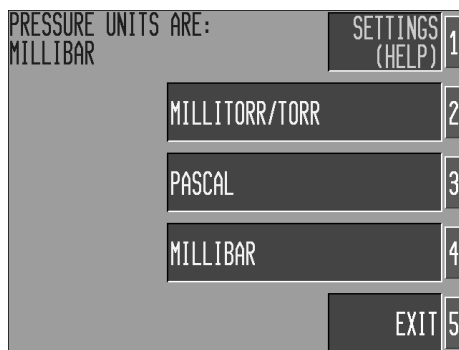

3.4.21 Gas Type

Display leak rate in either Air Equivalent or Direct Reading (He) by choosing the appropriate softkey. Note that changing from one type to another will change all programmed leak rate values (ie, internal calibrator, external calibrator, reject point) correspondingly.

3.4.22 Helium Type

Sets the MS-50 to either Mass 4 or Mass 3 tuning voltages. Current status is indicated in upper left corner of the screen.

Figure 3-28
Left:
 Select Gas Type

Right:
 Select Helium Type

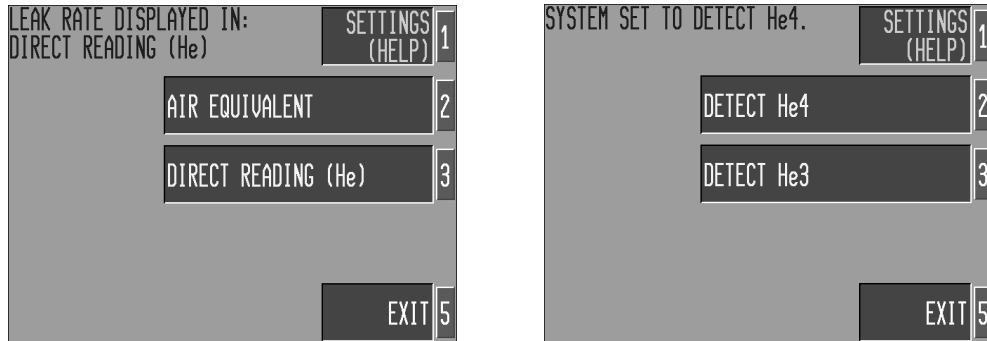

3.4.23 Test Port Display

Select [2] Show Test-port Graph or [3] Hide Test-port Graph to toggle Test Port bar graph display on or off.

Figure 3-29
 Set Test Port Bar
 Graph Display

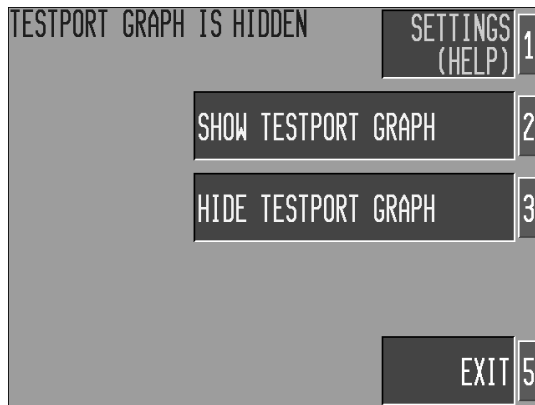

3.4.24 Cal. Temp

Used to enter an internal calibrator temperature (the temperature at which the unit’s internal leak rate standard was calibrated; this value is stamped on calibrator and indicated on the calibration certificate). The calibrator temperature value is factory preset. The only time this parameter will need to be changed is after the standard has been re-calibrated. Change the temperature by pressing [3] Increase or [4] Decrease. Press [2] Set Calib. Value to set internal calibrator leak rate value (see 3.4.13).

Figure 3-30
Set Calibrator Temp.

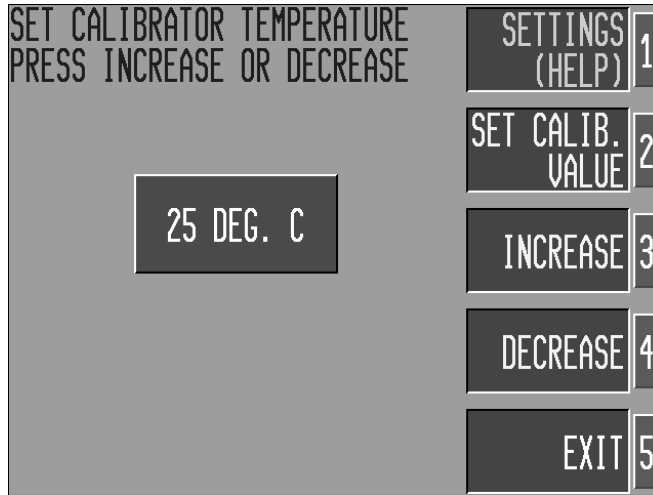

3.4.25 Selected Cal.

Selecting [2] Internal or [3] External instructs the MS-50 system to tune and cal check to either the internal leak rate standard, or to an externally connected calibrator.

NOTE:

When using an external calibrator, temperature compensation of the external leak standard is not provided.

Figure 3-31
Select
Internal/External
Calibrator

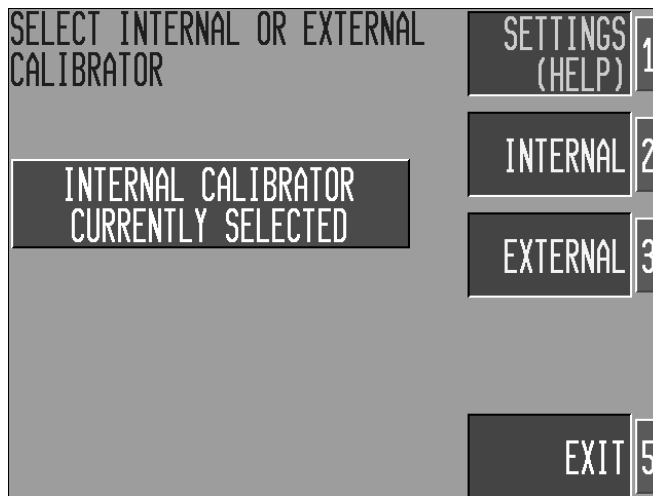

3.5 The Help/System Menu

Press [1] Help (System) on the Help/Settings menu (fig. 3-10) to access the Help/System menu (below). From this menu, the user may reference the MS-50's onscreen Help utility, adjust the system Time and Date settings, or change the selected Language display (English, French, and German options are available).

Figure 3-32
Help/System Menu



3.5.1 Help Menu

Press [2] Help Menu to use the MS-50's onscreen help utility. The Help menu is organized into two main categories: Console Controls (detailing User Panel key functions used during normal operation) and Service Panel (detailing key functions used exclusively in Service Mode).

3.5.2 Time and Date Menu

Select [3] Time and Date Menu to access the Set Time of Day and Set Calendar Date screens.

3.5.2.1 Set Time of Day/Calendar Date

Press [2] or [3] to select between the Time Of Day and Calendar Date screens and then press [3] Increase or [4] Decrease to adjust settings.

NOTE:

All time values are in 24-hour format.

Figure 3-33
Time & Date Menu



Figure 3-34
Set Time of Day

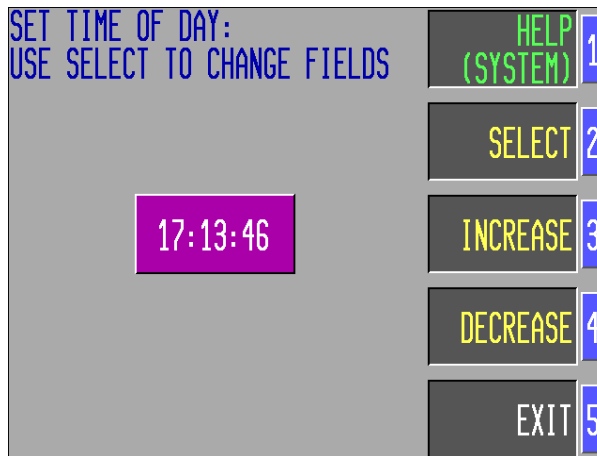
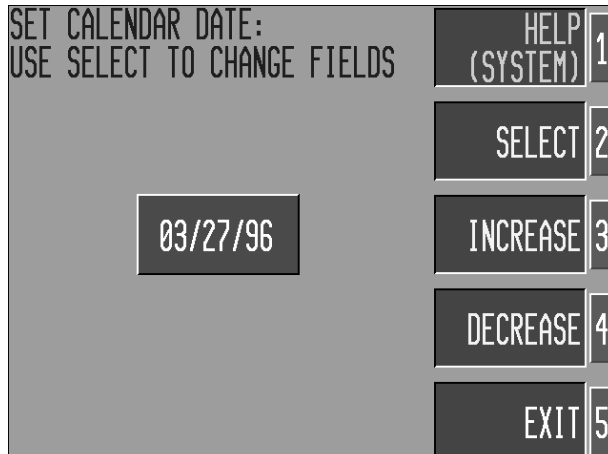

Figure 3-35
Set Calendar Date



3.5.3 Languages

The MS-50 supports English, French or German text display.

Select from the screen below to change the currently displayed language. Press [4] Language on the Help/System menu to access language selection and then select the desired language by pressing either [2] English, [3] French or [4] German.

Figure 3-36
Select Screen Text Display Language

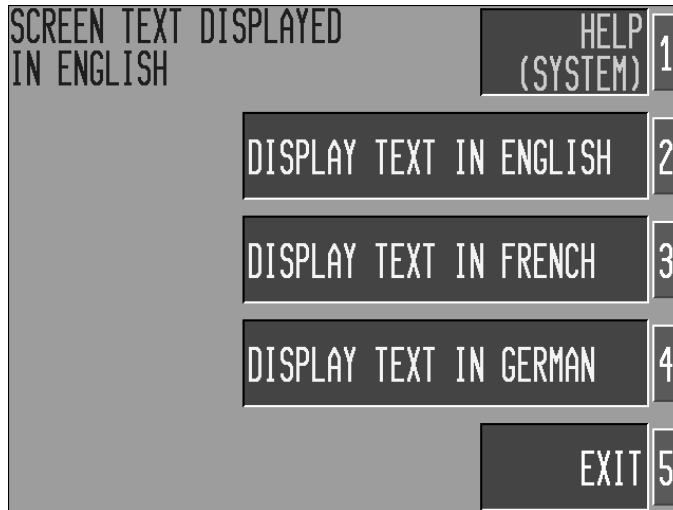

4.0 Introduction

This chapter provides detailed information on both the routine procedures required to maintain the MS-50 in peak operating condition, and the more advanced procedures of primary interest to Vacuum Instrument service technicians and trained customer personnel.

Topics discussed in this chapter include: MS-50 Service Mode and routine maintenance procedures, vacuum system contamination, cleaning, calibration and servicing of MS-50 components, and MS-50 error messages (a reference table identifying system faults and recommended corrections).

4.1 Service Mode

To perform many of the service and/or repair procedures described in this chapter, the MS-50 must first be placed into Service Mode. To activate Service Mode, turn the key-switch clockwise from **NORM** to **SERVICE** position. The CRT screen will immediately display a schematic of the MS-50 Vacuum System (**fig. 4-1**).

WARNING!

Only qualified Vacuum Instrument service technicians or users specifically trained by Vacuum Instrument should operate the MS-50 while in Service mode. Under no circumstances should individuals be assigned access to Service mode without a thorough knowledge of vacuum systems as well as the MS-50 system. Use by an unqualified operator may result in damage to the unit and/or personal injury.

In addition, only qualified service personnel should operate the unit when its electronics access panel (right side of unit) is removed. Potentially lethal high voltages are continually applied to the circuit boards and other areas within the unit during its operation. Failure to follow this precaution may lead to severe injury or death.

Figure 4-1
Service Screen

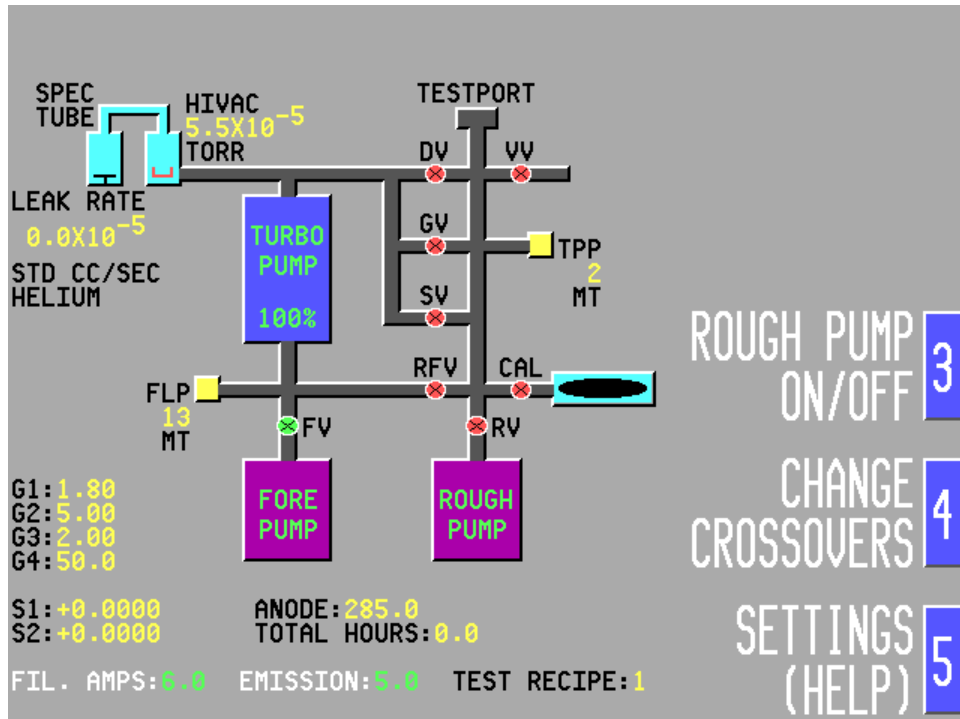

In Service Mode, the MS-50 may be operated and sequenced completely manually. In this mode, the vacuum system of the unit operates without its normal computer controlled safety interlocks. ***Contamination and/or damage to the unit will occur if the vacuum system is not properly sequenced!***

The Service Screen vacuum system schematic shows the operational state of all valves (Green = open, Red = closed), the Test Port, Hi-Vac and Foreline manifold pressures, the amplifier gains (G1 - G4), the anode (peak) voltage, the filament current (in amps), and the emission current (in milliamps) It also displays the Leak Rate and the selected flow mode.

NOTE:

When returning from the Service mode to Norm mode, the MS-50 requires a short interval (approximately fifteen seconds) to accurately acquire background and other system measurements. During this time, the system computer will prohibit any testing and a warning "beep" sounds whenever the Start switch is pressed. At the end of this fifteen second time period, a test cycle may be commenced normally by pressing the Start switch.

Key to Service Screen Symbols:

Leak Rate

Displays current leak rate in std cc/sec, Pascal M3/sec, or millibar liters/sec. If system is set to detect He3, He3 is displayed below leak rate; if set for direct helium reading, HELIUM is displayed; if set for He4 or Air Equivalent, no notation appears onscreen.

Amplifier Gains (G1-G4)

- G1:** Gross mode gain; set by user via Amp Gain up/down keys
- G2:** Reverse mode gain; set by system
- G3:** Direct mode gain; set by system
- G4:** Sniff mode gain; set by user via Amp gain up/down keys

Fil. Amps

Displays filament supply current in DC amps; Maximum: 6.0 amps.

Anode

Anode Voltage. Displays accelerating voltage of mass spectrometer in DC volts.

Emission

Displays filament emission current in DC mA. Properly operating filament has emission of 5mA.

HiVac

Displays high vacuum pressure in Torr/mBar/Pascal. If filament is off, displays OFF.

Turbo Pump

Percentage indicates relative operating speed of pump. When pump is turned on, "Turbo Pump" legend appears green.

Fore Pump

Indicates pump status; when pump is turned on, "Fore Pump" legend appears green.

Rough Pump

Indicates pump status; when pump is turned on, "Rough Pump" legend appears green.

FLP

Foreline Pirani. Foreline pressure indicated in milliTorr [MT], milliBar [MB], or Pascal [PA].

TPP

Testport Pirani. Testport pressure indicated in milliTorr [MT], milliBar [MB], or Pascal [PA].

Valve Status

If valve symbol is green, valve is open.
If valve symbol is red, valve is closed.

Valve symbols are labeled as follows:

- DV** Direct valve
- VV** Vent valve
- GV** Gross valve
- SV** Sniff valve
- RFV** Reverse flow valve
- FV** Foreline valve
- RV** Rough valve
- CAL** Calibrator valve

Rough Pump On/Off

Press softkey [3] to toggle Rough pump on or off.

Change Crossovers

Press softkey [4] to change Direct or Reverse flow mode crossover pressure setpoints.

Settings (Help)

Press softkey [5] to display Help/Settings Menu. Changes may be made to system parameters and stored.

Total Hours

4.2 Periodic Maintenance

This section details the periodic service and maintenance routines that must be performed to ensure satisfactory operation of the MS-50. The leak detector should be serviced by a skilled operator or service technician within the intervals given below. If the leak detector is used in dusty surroundings, or if the parts being tested contain matter that may rapidly contaminate the vacuum system, these tasks should be performed more frequently.

Periodic Maintenance Functions:	Frequency:	Section:
▪ Grease Test Port O-Ring:	Weekly	4.2.1
▪ Check Air Filters:	Weekly	4.2.2
▪ Check Oil Level in Rough and Foreline Pumps	Monthly	4.2.3
▪ Check Exhaust Filter Cartridge	Monthly	4.2.4
▪ Change Oil in Rough and Foreline Pumps	Semi-annually	4.2.5
▪ Replace Turbo Pump Cartridge	Annually	4.2.6
▪ Recalibrate Internal Leak Standard	Annually	4.2.7

4.2.1 Grease Test Port Centering O-Ring

A properly sealing test port O-ring is essential in assuring rapid pump down of a test object. The O-ring should be inspected frequently (at least once each week).

To access the O-ring, remove the 1 1/8” connector on top of the test port. With a hooked, nonmetallic instrument or by hand, carefully remove the O-ring. Take care not to damage the O-ring. Once removed, wipe it with a lint free cloth and inspect it carefully for any damage. Specifically, look for any cuts, wear or flat spots. Install a new O-ring if any damage is observed. Whether installing a new O-ring or reinstalling an existing one, lubricate the O-ring with a thin film of vacuum grease (Dow Corning High Vacuum grease is recommended). Re-install the O-ring into the test port. Again, be careful to avoid scratching any sealing surfaces.

4.2.2 Checking Air Filters

The MS-50 has two reusable wire mesh filters that clean the cooling air drawn into the unit. The filters are located behind the louvered gray kick panel covering the lower front side of the unit.

To remove the filters for cleaning, pop off the kick panel and slide the filters out. The filters should be cleaned with compressed air (in the reverse direction of normal air intake) or washed with soap and water.



WARNING!

When removing fan filters, be careful to keep hands clear of moving fan blades.

4.2.3 Checking Exhaust Filter Cartridge in Rotary Vane Mechanical pumps

The rough and fore pumps use a coalescing type filter with a replaceable cartridge. The filter is attached to the inside rear of the unit. The filter may be removed by disconnecting the KF25 clamps and centering rings at each end (see illustration, fig. 4.2). Examine the filter cartridge; if it is discolored or saturated, replace it with a new filter.

4.2.4 Checking Oil Level In Rotary Vane Mechanical Pumps

The MS-50 is equipped with rotary vane mechanical pumps (Roughing and Foreline). Each pump has a transparent oil level gauge that allows the operator to observe the amount of oil in the pump, as well as its color.

To observe the oil level, and to access filler ports for the pumps, remove the left side access panel. The locations of the oil level gauges and filler ports, as well as the unit's pump oil drain cocks are indicated in figure 4-3.

Oil should be added to a pump whenever the oil level window indicates that the pump oil supply is low. If the oil is discolored, it should be changed immediately (the procedure for changing pump oil is described later in this section).

It is possible for pump oil to become contaminated with helium. Refer to 4.3.3 for information on indications of helium-based oil contamination.

Figure 4-2

MS-50 Exhaust Filter Components

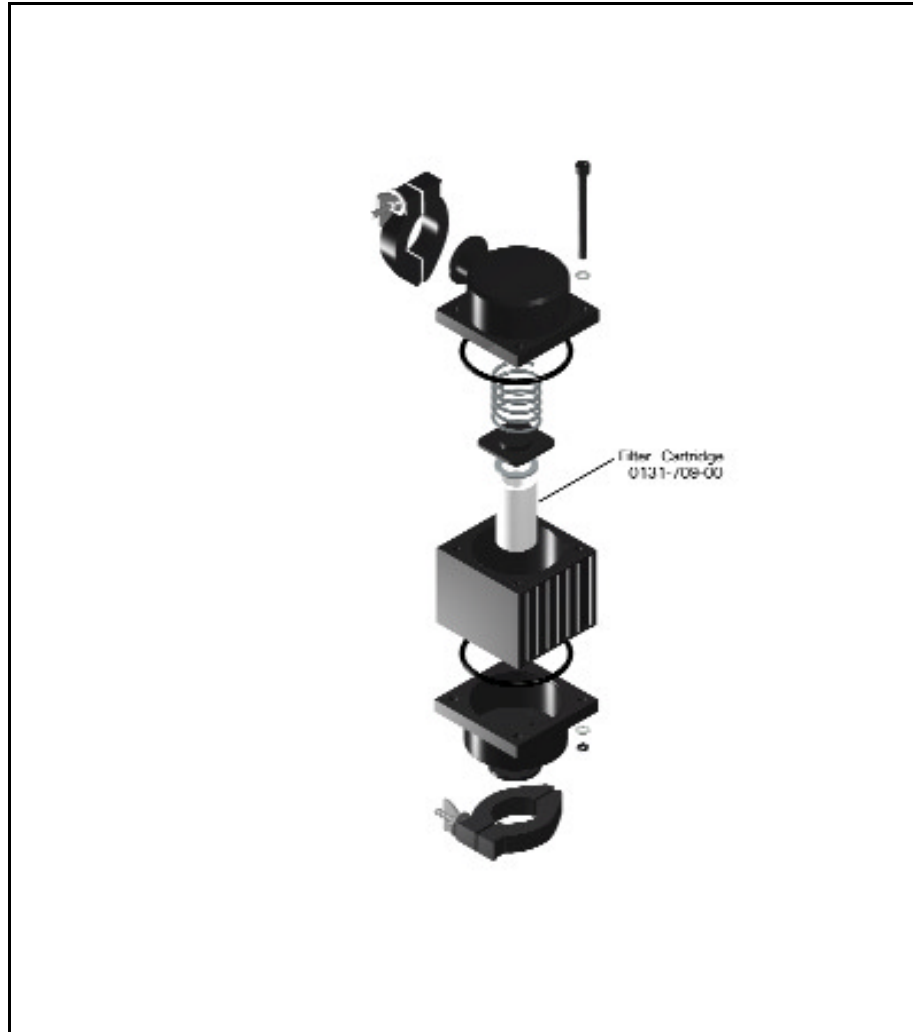
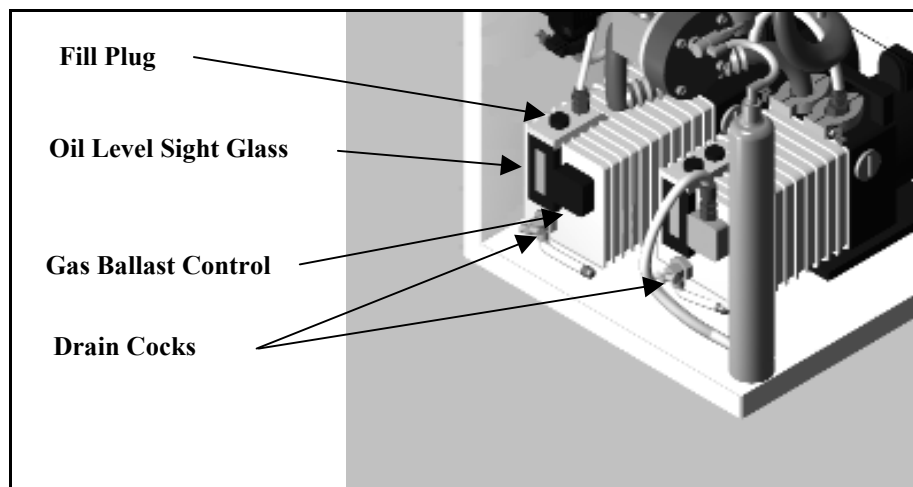

Figure 4-3

MS-50 Assembly Detail

**Fore Pump (Left)
Rough Pump (Right)**



4.2.5 Changing the Oil in Rotary Vane Mechanical Pumps

When changing the oil in either the Roughing or Foreline pump, the oil must be hot to obtain complete drainage. If the oil is not hot, run the pumps for at least fifteen minutes to warm up the oil.

The pumps must be shut down prior to an oil change. Running a pump without a sufficient amount of oil will quickly damage the pump.

1. Turn off power to the MS-50 using the front panel I/O switch. Remove the left side access panel.
2. An oil drain cock is provided on each pump. The MS-50 is shipped with a length of flexible tubing connected to each drain cock. Remove the plastic cap from the end of each tube and place a container large enough to collect the spent oil (approximately one quart) beneath the drain cocks.
3. Loosen and remove the pump filler plugs to allow the oil to drain faster.
4. Open the drain cocks and allow the oil to drain out of the pump. When the oil has completely drained from the pumps, close the drain cocks.
5. Position a funnel in the filler opening and refill the pumps to a point approximately midway between the two lines on the oil level sight glass. Replace the filler plug.

Important!

*Use only manufacturer recommended oil such as **Inland 19** or equivalent. The use of other oils may result in poor pressure performance and rapid contamination. Do not use solvents or light flushing oils, since complete removal is difficult and their higher vapor pressure prevents attainment of required vacuum.*

6. Replace the left side access panel and power up the leak detector. Allow the unit to run for at least five minutes. This will circulate oil through the pump and flush out any contaminants. Repeat Steps 3 & 4. If contaminants are still visible in the pump oil, repeat Steps 3 & 4 until the pump oil appears free of contaminants.

Important!

Before restarting the MS-50, double check oil level sight gauges to make certain that the pumps are filled with a sufficient amount of oil.

4.2.6 Replacing the Turbo Pump Operating Fluid Reservoir Cartridge

The turbo pump operating fluid must be changed at least once a year. Always change the complete operating fluid reservoir cartridge. Replacement cartridges are available from Vacuum Instrument (P/N 1660-262-00).

NOTE:

Cleaning of the turbo pump must be in accordance with the procedures recommended by the manufacturer. These procedures are detailed in the pump manufacturer's manual that is shipped with the MS-50. For questions about servicing the turbo pump, contact the Customer Service Department at Vacuum Instrument.

4.2.7 Re-calibrating the Internal Leak Standard (Calibrator)

The internal leak standard, installed in the MS-50 at the factory, will last indefinitely. However, the standard should be re-calibrated annually, a procedure that necessitates removal of the standard. The standard is returned to Vacuum Instrument for re-calibration. An exchange program is available at VIC, call service/sales for further information.

Removing the Internal Leak Standard (Calibrator):

The procedure for removing and replacing the internal leak standard is as follows:

1. Turn off power to the unit.
2. Remove the front access panel (pulling along the beveled bottom edge causes the panel to “pop” from the chassis). The leak standard will be clearly visible (see *Appendix A, Overall Assembly Drawing*). Disconnect the temperature sensor electrical connector and cut any tie wraps surrounding the sensor.

3. Push the quick release button on the leak standard body. Remove the temperature sensor and leak standard by pulling the standard down, then out, while the temperature sensor is still attached.
4. Remove the temperature sensor from the leak standard and reattach to a new leak standard.

Important!

Make certain that the temperature sensor is properly oriented when reinstalled to avoid contact with the unit's front access panel.

5. Reattach the leak standard and temperature sensor to the leak standard valve block. A click will indicate that the leak standard has been properly connected.
6. Follow the instructions in the next section to program new calibrator leak rate and temperature values.

Reprogramming Calibrator Values After Reinstallation:

The leak rate and temperature values stamped on the MS-50 internal calibrator are stored in the memory of the computer. The leak standard reference values are initially entered at the factory.

The internal leak rate standard should be removed and sent to Vacuum Instrument for re-calibration annually. An exchange program is available at VIC, call service/sales for further information. After reinstallation, the leak rate and temperature of the re-calibrated standard must be entered, as follows:

1. Place unit into **Set** mode. From the **Help/Settings Menu**, select **Internal Cal** (see 3.4.13).
2. Press the [3] **INCREASE** or [4] **DECREASE** softkeys to match the programmed calibrator value to the value stamped on the calibrator.
3. Press [2] **SET CALIB. TEMP** to bring up the **Set Calibrator Temperature** screen (see 3.4.24). Use the Increase/Decrease soft-keys to adjust the calibrator temperature setting until it matches the value stamped on the calibrator. When finished, press [5] **EXIT** to return to the Help/Settings Menu.

4.3 Vacuum System Contamination

All leak detectors are subject to contamination of the vacuum system by repeated exposure to gases and other matter drawn from test objects during normal testing. This matter will settle throughout the vacuum system. Special consideration should always be given to contamination of the mass spectrometer and the oils and filters of the rotary vane mechanical pumps. As a result of contamination, system performance will drop and sensitivity will decrease. Cleaning and recalibration of the vacuum system is necessary to restore the unit to optimum performance.

4.3.1 Indications of Contamination

The vacuum system is considered contaminated if any of the following conditions exist:

- The amplifier gain indicators for **G2** and **G3** display a gain of **8** or higher. This indicates that the sensitivity of the mass spectrometer has decreased and the automatic gain compensation of the unit is reaching its limit. Verify tuning by using the automatic **Tune** function. If, following the tuning procedure, the **G2** and **G3** values are not lower than previously indicated, the mass spectrometer should be removed from the high-vacuum system and cleaned.
- The high-vacuum pressure is erratic. This requires that the high-vacuum section be cleaned.
- The plugged test port cannot be pumped to less than 20 milliTorr. This condition indicates that the oil in the roughing pump may be contaminated and needs to be replaced.
- The foreline pressure cannot be pumped to less than 50 milliTorr. This condition indicates that the oil in the foreline pump may be contaminated and needs to be replaced.
- High, steady state background levels of Helium are detected, even after prolonged pumping and purging with nitrogen. Again, this may be an indication of pump oil contamination.

Note that it is possible that the symptoms listed above may be due to conditions other than contamination. The following problems should be considered and eliminated prior to proceeding with contamination-related service:

- Leak in the vacuum system
- Incorrectly tuned spectrometer
- Malfunctioning turbo-molecular pump

4.3.2 Sensitivity Check

As the MS-50 is exposed over time to gases drawn into its vacuum system, matter contained in these gases tends to contaminate the mass spectrometer, reducing system sensitivity. During the **Tune** procedure (see 3.5.1), the MS-50 computer senses this reduction and compensates by boosting the helium signal amplifier gain. Monitoring changes in the amplifier gains can, therefore, provide a reliable indication of leak testing sensitivity.

To check the amplifier gains, place the MS-50 into **Service** mode. The vacuum system status screen appears, displaying in its lower left corner gains **G1 - G4**. If the unit is being tuned regularly, the **G2** and **G3** values will increase over time as vacuum system contamination increases (**G1** and **G4** are set by the user and, therefore, are not useful for checking sensitivity).

Continued accumulation of contaminants will eventually exhaust the system's "reserve" gain. If the system has been tuned and either the **G2** or **G3** values remain greater than **8**, cleaning and re-calibration of the mass spectrometer assembly is required.

4.3.3 Foreline Pump Oil Contamination

Repeated exposure to high levels of helium, particularly when testing objects with large leaks, may cause the foreline pump oil to become contaminated. Helium, along with other gases, becomes dissolved in the oil and trapped in the fore-pump. This type of contamination may be exhibited in two ways:

- High background helium is measured that cannot be pumped away.
- An unstable leak rate is indicated, caused by excess helium released from the pump at regular intervals.

A high background level of helium will prevent the MS-50 from testing in its most sensitive ranges. An unstable leak rate will complicate testing and will render the tuning and calibration functions unreliable.

Purging the foreline pump with dry nitrogen will help prevent contamination. Facilities dry nitrogen is connected to the MS-50 through a bulkhead fitting marked **NITROGEN** on the rear of the unit (see **1.2, Installation** for nitrogen purging setup procedures).

If dry nitrogen is not available, or if the helium load is so significant that purging does not prevent oil contamination, the pump's **gas ballast** may be opened periodically to de-gas the pump oil. This should be done only if the background helium rate is excessive or if the leak rate becomes unstable.

To access the fore-pump ballast, remove the left side access panel. The gas ballast is controlled by a black knob on the pump similar to that shown in figure 4-4.

Figure 4-4
Opening the
Gas Ballast

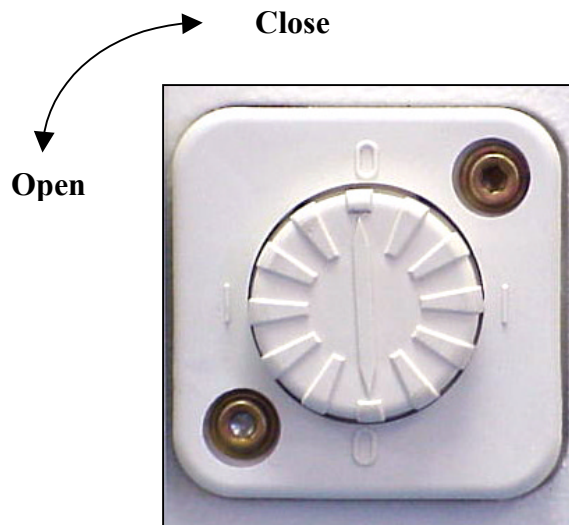

Before opening the ballast, make sure that the unit is in standby (Ready to Test) mode (no test valves open). The ballast should be kept open for a minimum of thirty (30) minutes to allow the helium to be completely expelled from the oil. After the oil is degassed, the gas ballast should be closed and the MS-50 should be allowed to remain in the standby mode for fifteen (15) minutes. This will allow the background level to settle.

To open the gas ballast, turn the black knob on the pump one quarter turn counter clockwise until the arrow points to the "1" symbol. When the ballast is fully open, the knob will pop out slightly, and there will be a hissing noise as air is drawn into the pump.

Close the ballast by pushing inward on the knob, then turning one quarter turn clockwise until the arrow is pointing to the "0" symbol.

Occasionally, the fore pump will become saturated with helium to the point that purging with dry nitrogen and de-gassing the oil through the gas ballast will not be entirely effective. If the background and instability problems are not sufficiently solved through these measures, change the pump oil (see 4.2.5).

4.3.4 Venting the Vacuum System

Complete venting of the vacuum system is always necessary prior to removal of vacuum system components for cleaning, service, and repair.



WARNING!

Venting of the Vacuum System should be performed by qualified personnel only. Improper sequencing of the vacuum system may result in damage to the unit or operator injury.

The procedure for venting the vacuum system is as follows:

1. Place the unit in **Service** mode.
2. Press the **VALVE** keys in the user panel **Service Mode** section to toggle **all** valves closed except the **FORE** (foreline) valve.
3. Verify that the filament is turned off. Press the **TURBO** on/off toggle button to shut down the turbo-molecular pump. Wait for the turbo pump to spin down to under 50% of full speed

NOTE:

Turbo pump speed rate (in percent) is indicated on Service Mode vacuum system schematic display (see fig. 4-1).

4. Press the **FORE** key, closing the foreline valve.
5. Press and hold the **VENT** button to open the Vent valve.
6. Press the **DIRECT** key to open the Direct valve.

NOTE: *It is not unusual to hear increased noise from the fore-pump as it pulls air past the foreline valve (which seals in one direction only, favoring the turbo pump). If you wish to avoid this condition, the electrical connection to the fore-pump may be temporarily unplugged.*

7. Close the Vent and Direct valves.
8. Turn off the unit. The vacuum system is now fully vented.

4.3.5 Vacuum System Cleaning Requirements

When it is determined that the vacuum system is contaminated, vacuum system components will need to be cleaned and serviced. Since contamination should not be a frequent occurrence, it is recommended that the components listed in this section be cleaned and/or serviced at the same time.

Parts that may require cleaning are:

- ⁿ
- ⁿ **Mass Spectrometer (including the Source, Collector and housing)**
- ⁿ **Vacuum System Valves**
- Turbo Pump**

NOTE: *Cleaning the turbo pump is a complicated task that should never be undertaken by personnel lacking **thorough** familiarity with the pump manufacturer's service guidelines and procedures. It is strongly recommended that you contact Vacuum Instrument prior to cleaning or servicing the turbo pump.*

To access the internal components of the MS-50, remove the unit's front and left side panels.

4.3.6 Cleaning Procedure for Contaminated Parts

When the vacuum system becomes contaminated, it is necessary to disassemble and clean all components that are affected. Acceptable cleaning procedures for vacuum apparatus such as electron tube parts, test chambers, etc., are generally appropriate for cleaning MS-50 vacuum components.

A few important things to be aware of when cleaning MS-50 vacuum system components:

- When handling vacuum system components, use only lint-free (for example, latex) gloves and lint-free cloth. Touching any component with bare hands will leave an organic residue on the component that will outgas and negatively affect subsequent leak detection test results.
- **Never** use solvents of **any** kind on rubber parts (ie, O-rings, valve coil end plungers).



WARNING!

Avoid the inhalation of cleaning fluid vapors at all times! Also, extreme care should be taken when working with flammable substances such as acetone.

Cleaning Procedure:

Immerse components in a cleaning solvent (such as acetone, alcohol Isopropanol, trichlorethylene, Alcinox). After removing from the solvent, thoroughly rinse the part in hot water and dry immediately. Heating the components, prior to their re-assembly is the final stage of cleaning. A heat gun is recommended for this task.

Changing O-Rings:

Never remove synthetic rubber O-rings with a metal tool; this can scratch the O-ring groove, increasing the potential for a leak to occur. Use a tool made from plastic, wood, or any other soft material.

To remove an O-ring, insert the tool between the inside of the O-ring and its groove. Slide the tool around the inside of the O-ring. This will cause the O-ring to pop up (the O-ring may have to be held on its opposite side to prevent it from turning in the groove).

Worn or damaged O-rings and gaskets should be replaced at the time of re-assembly. Before a new O-ring is installed, it should also be wiped clean with a lint free cloth, inspected and lubricated with a very light film of vacuum grease. Use vacuum grease as sparingly as possible since it later may become a source of system contamination.

4.3.7 Cleaning the Mass Spectrometer

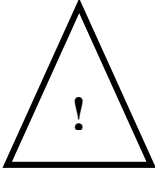
**WARNING!**

When cleaning or servicing Mass Spectrometer components, it is imperative that standard precautions to protect the collector assembly against static discharge (i.e., wrist strap with grounding cord, static-dissipate table mat, static shielding bag, bench top ionizer) are employed.

(Refer to figure 4-5 for an exploded view of the Mass Spectrometer)

1. Vent the vacuum system (per 4.3.4) and turn off power to the unit.
2. Remove the mass spectrometer assembly from the unit, as follows:
 - Disconnect electrical connectors from the Source and Collector
 - Remove screws securing stabilizing bracket to frame. Loosen KF clamp and remove spectrometer.
 - Remove the spectrometer magnets. Be sure to note the polarity markings on the magnets and the mounting slots used prior to removal.
3. Disassemble the two half sections of the mass spectrometer housing and remove the center slit plate and O-ring.
4. Remove the Source and Collector from the mass spectrometer housing. Remove the heat sink from the Source to facilitate cleaning.
5. Clean the Source and Collector housings. The interior of each section should be bead blasted to remove all stains (*do not use aluminum oxide powder!*). Blow out the blast residue with dry, oil-free air. The sections should then be cleaned ultrasonically in alcohol Isopropanol (or equivalent) and dried with a hot air gun. Always wear lint free gloves when handling the sections. Reassemble the two sections and install a new O-ring, first coating the O-ring with a very light film of high vacuum grease.

6. Clean the Source as follows:

- Remove the source O-ring and wipe away Remove any excess grease from the groove.

- Remove the filaments (see section 4.3.8). Clean the oval raceway using a fine emery cloth held with needle nose pliers or a tweezer. Do not use excessive force; any bending or shifting of the filament area may cause an electrical short. Rinse the source in alcohol Isopropanol or equivalent (ultrasonically, if possible) Install new filaments as per 4.3.8.

7. Clean the Collector as follows:**Important!**

Remember to follow static precautions to protect sensitive circuitry when handling the Collector.

- Remove the collector O-ring and wipe away any excess grease from the O-ring groove.

- Clean ultrasonically in hot alcohol Isopropanol or equivalent for two minutes.

- Bake the entire assembly at **50°C** for 30 minutes.

- Apply a light film of vacuum grease to the O-ring and reinstall. Reinstall the collector assembly into the mass spectrometer housing.

Figure 4-5 MS-50 Mass Spectrometer Assembly

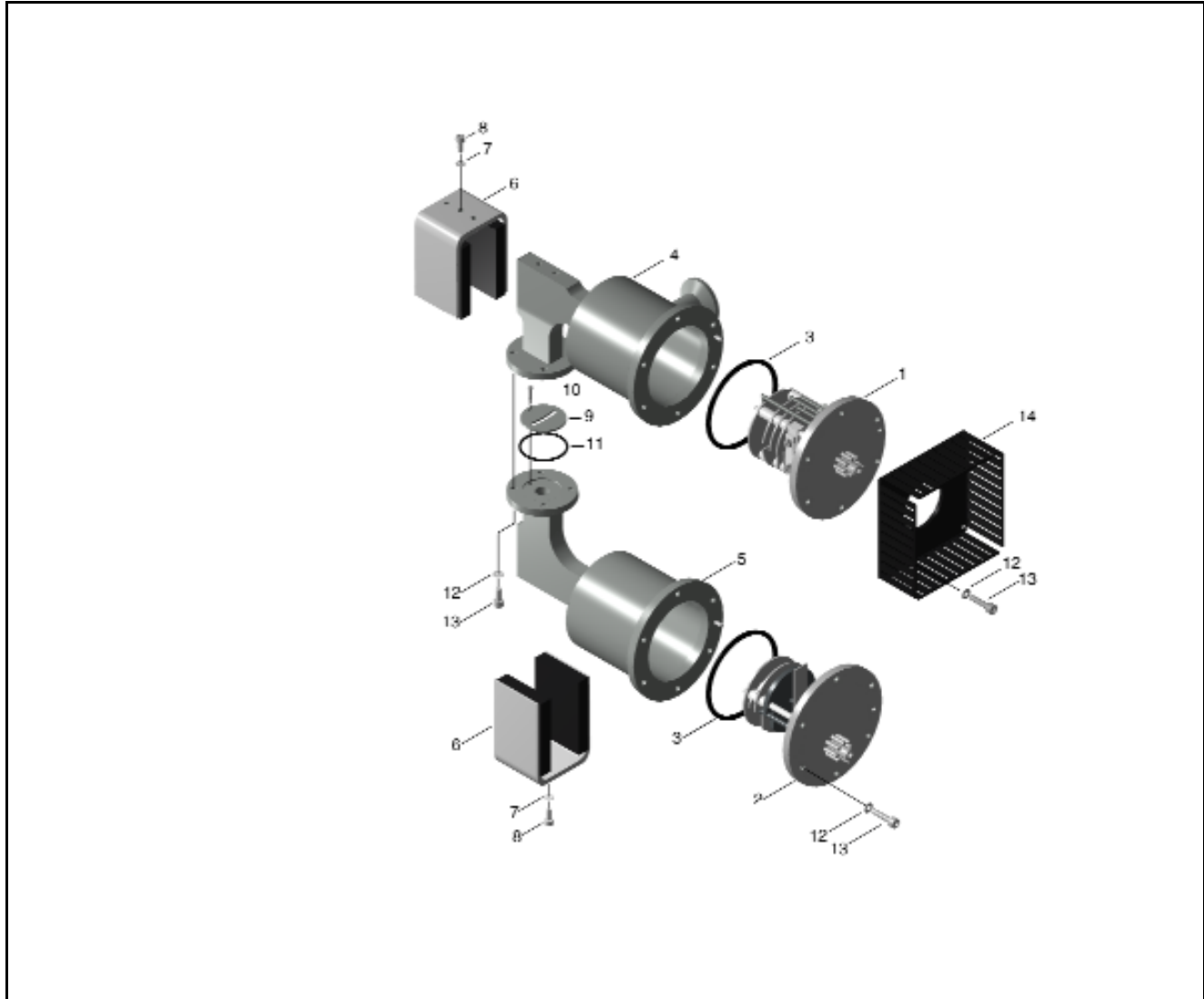

Figure 4-5 MS-50 Mass Spectrometer Assembly

<u>Item #</u>	<u>VIC P/N</u>	<u>Description</u>
1	0137-014-00	Source Assembly
2	0136-051-00	Collector Assembly
3	0011-037-00	O-Ring, 2 1/2" I.D. x 1/16" W
4	0139-011-00	Source Body
5	0135-053-00	Collector Body
6	0130-151-00	Magnet Assembly
7	Commercial	Lockwasher, Split #4
8	Commercial	Screw (Socket Head) #4-40 x 3/8
9	0130-195-00	Slit Plate
10	0130-168-00	Screw (Vented), #2-56 x 3/16
11	0011-024-00	O-Ring, 1 1/8" I.D. x 1/16" W
12	Commercial	Lockwasher, Split #6
13	Commercial	Screw, Socket Head, #6-32 x 1/2"
14	0137-232-00	Heatsink

4.3.8 Replacing the Filaments

To replace burned out filaments the MS-50 must be first be vented to permit the removal of the Source from the Mass Spectrometer (see fig. 4-5). The procedure to replace filaments is:

1. Vent the entire system as per 4.3.4 and turn off unit.
2. While holding the source assembly, gently pull off the source connector.
3. Loosen the four screws that hold the heat sink onto the source assembly. Remove the four screws and pull the heat sink off the source assembly.
4. Loosen and remove the remaining two screws holding the source assembly in place.
5. Remove the source assembly.
6. On the source assembly, remove the two outer nuts that hold the filament contacts in place.
7. Gently bend the filament contacts away and down from the source assembly.
8. Remove the two nuts that hold the ceramic spacer in place. Remove the spacer.
9. Remove the filament assembly.

New Filament Installation:

10. Carefully bend both filament contacts slightly more than 90° away from the filament side of the assembly.
11. Place the filament on the source assembly, inserting the filament posts into the slots provided on the ceramic block.

Figure 4-6 Replacing the Source Filaments

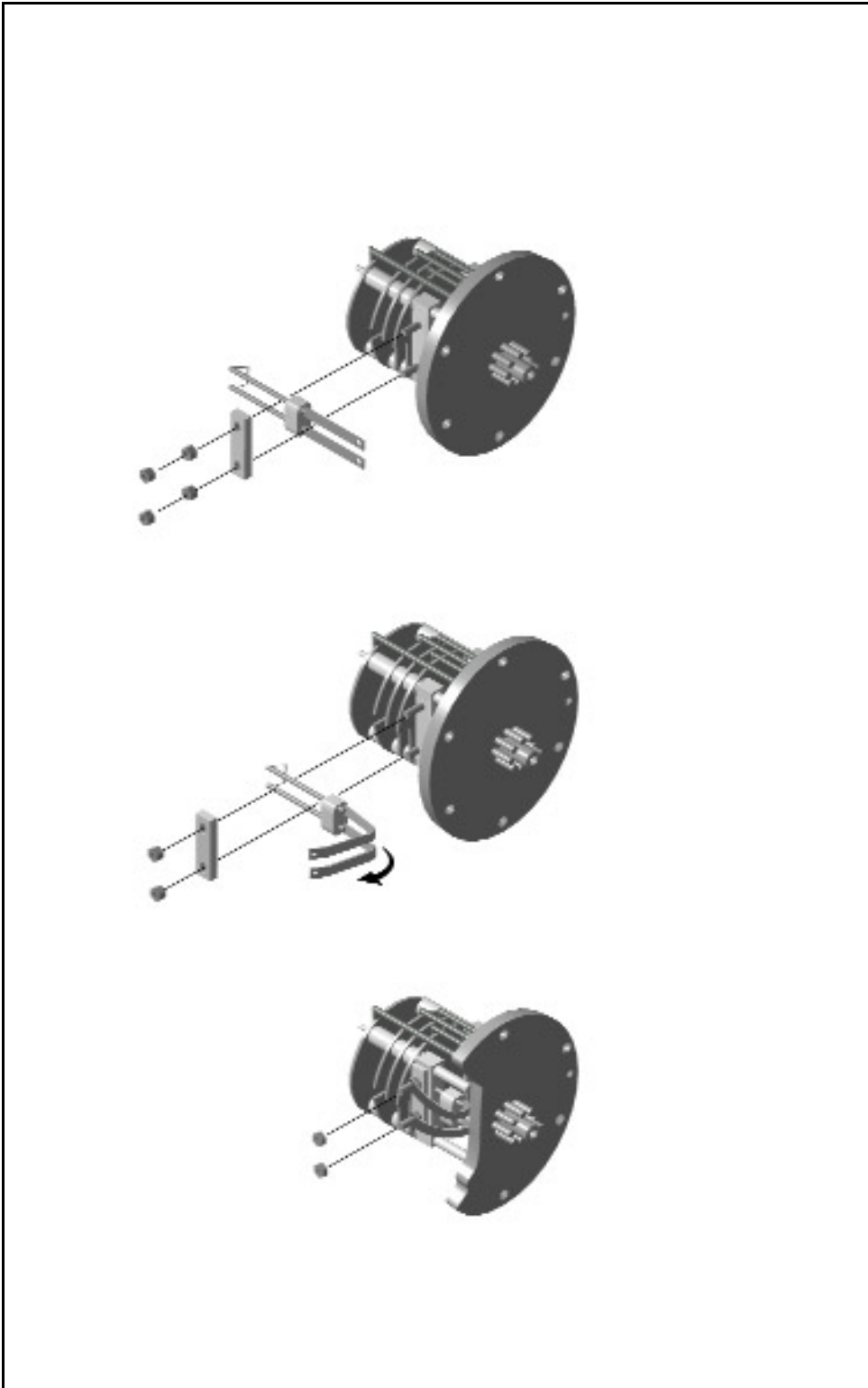

12. Place the ceramic spacer on the source assembly. Reattach the spacer with the nuts removed in Step 8, but do not tighten.
13. Loosen screws securing filament to the ceramic block and adjust filament by sliding up or down until the **TOP EDGE** of the filament is aligned with the center of the slot in the source assembly (see below).

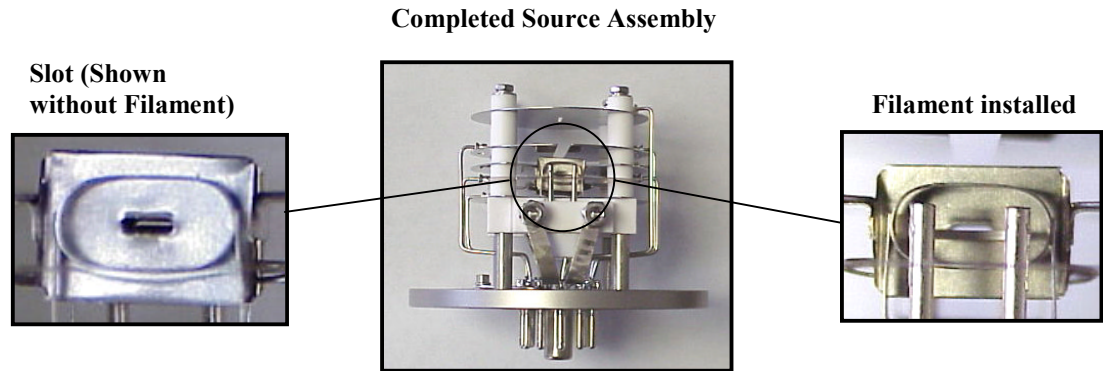

14. Lightly tighten the nuts removed in Step 8 so that the filament assembly is secured to the source housing.

NOTE:

Do not over-tighten the nuts. Over tightening will cause the ceramic block to crack.

15. Bend the filament contacts so that the holes in the contacts fit over the stud posts of the source. Replace and tighten nuts holding the contacts in place.
16. Remove the O-ring from the source assembly. Inspect the O-ring; if damaged or worn, discard and replace. If the O-ring is in good condition, clean using a dry, lint-free cloth.
17. Apply a thin coating of vacuum grease and reinsert the O-ring back into the O-ring slot.
18. Reattach the source assembly with the two screws removed in Step 4.
19. Reattach the heat sink that covers the source assembly with the screws removed in Step 3.
20. Reattach the source electrical connector to the source assembly.

4.3.9 Valve Cleaning

A prevalent cause of vacuum system leakage is faulty valve closure. Valve seats and seals can become dirty or contaminated with use, causing small leaks that must be corrected in order for the leak detector to function properly. If a leak develops, or the system becomes contaminated, the valves should be inspected and cleaned, if necessary. If a valve seal is damaged, the valve should be replaced. Generally, valves exposed to low pressure and high flow are the most likely to be the cause of a leak and should be serviced first.

All valve servicing is performed while the unit is in **Service** mode. In order to easily access the valve block, the left side and front access panels need to be removed. Refer to figure 4-7 for an exploded view of the valve block.



WARNING!

Never use metal tools or sharp objects to inspect a valve seat in the valve block! Any scratch will irreparably damage the seat.

4.3.10 Servicing the Direct, Reverse, and Vent Valves

1. Vent the entire system (as per 4.3.4) and turn off power to the unit.
3. Remove the wires from the electrical connectors on the valve coils. Make note of which wires are connected to each metal prong.

The Direct and Vent valves are connected by a yellow wire to the upper prong, and a striped wire to the lower prong; The Reverse valve is connected by a white wire to the upper prong, a striped wire to the lower prong, and a green and yellow striped wire to the outer prong.

The Direct and Vent valve coils are supplied with 24VDC; the Reverse valve coil is supplied with 115VAC.

3. Remove the four screws and washers connecting the valve coils to the valve block. Remove the valve assembly.
4. Remove the plunger and spring from the valve coil.

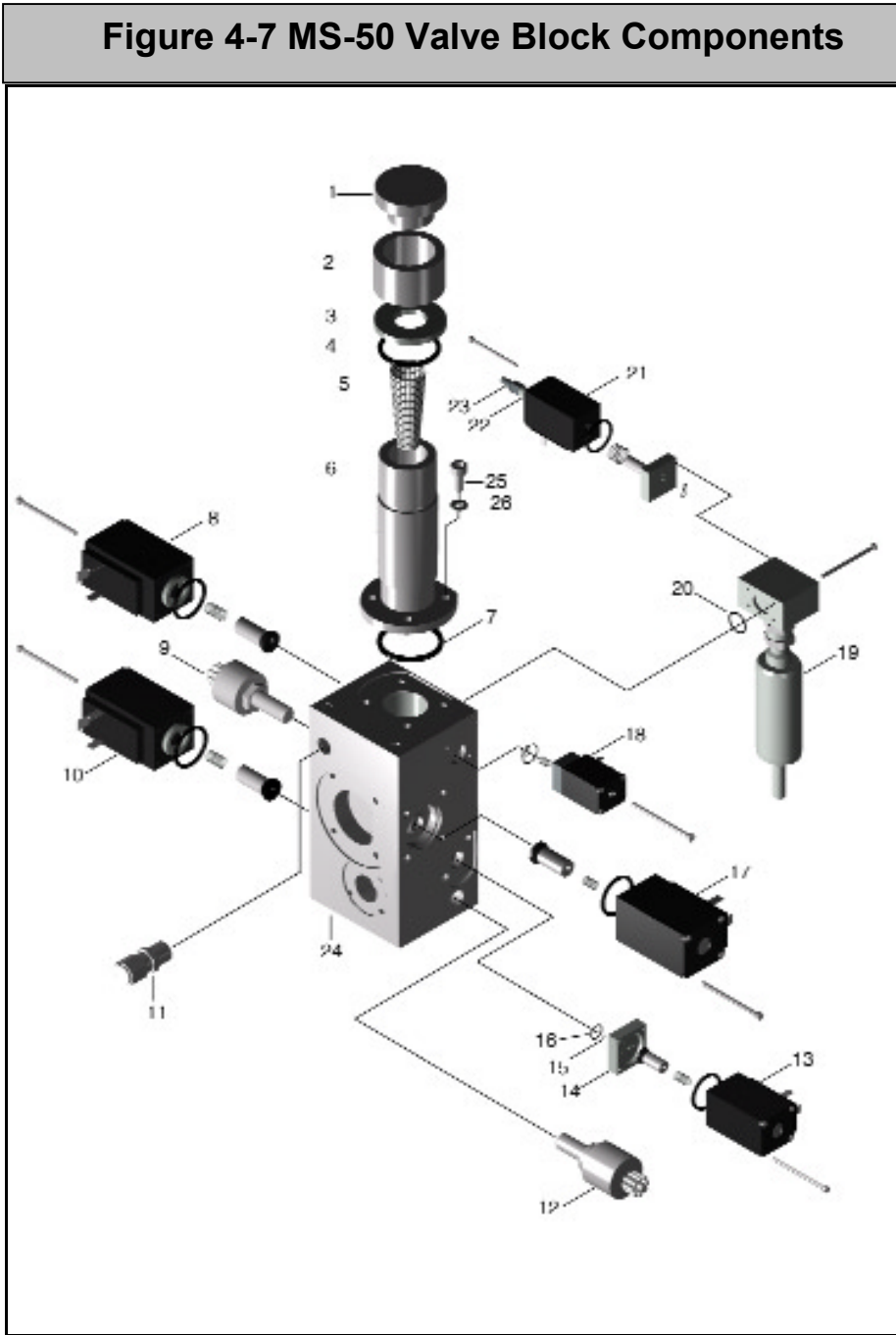

Item #	VIC Part #	Description
1	0126-284-00	Blank Plug, Test Port
2	1621-229-04	Nut, 1 1/8" Quick Connect
3	3140-003-00	Washer, 1 1/8" Quick Connect
4	0011-216-00	O-Ring, 1 1/8" ID X 1/8" W
5	1890-179-00	Inlet Filter
6	0139-202-00	Test Port
7	0011-024-00	O-Ring, 1 1/8" ID X 1/16" W
8	0137-120-02	Vent Valve
	0011-023-00	Replacement O-Ring, Vent Valve
9	0137-702-00	Pirani Gauge, Test Port
10	0137-120-00	Reverse Valve
	0011-023-00	Replacement O-Ring, Reverse Valve
11	1621-266-02	Connector, 1/4 T to 1/4 NPT
12	0137-702-00	Pirani Gauge, Foreline
13	1890-285-00	Gross Valve
	0019-022-01	Replacement O-Ring, Gross Valve
	800552	Screw, Slotted Cheese Head, M4 X .7 X 60mm
14	0139-209-00	Gross Leak Assembly
15	0011-019-00	O-Ring, 13/16" ID X 1/16" W
16	0018-007-00	O-Ring, 7/64" ID X 1/16" W
17	0137-120-02	Direct Valve
	0011-023-0	Replacement O-Ring, Direct Valve
18	1890-287-00	Sniff Valve
	0019-014-00	Replacement O-Ring, Sniff Valve Body
	0019-006-01	Replacement O-Ring, Sniff Valve Manifold
	0019-013-01	Replacement O-Ring, Sniff Valve Manifold
	0139-015-00	Calibrator Assembly (Includes Calibrator Body, Calibrator Valve and Mounting Block, and Temperature Sensor)
19	0137-016-00	Calibrator Body
20	0011-014-00	O-Ring, 1/2" ID X 1/16" W
21	1890-288-00	Calibrator Valve
	0019-022-01	Replacement O-Ring, Calibrator Valve Body
	0019-007-01	Replacement O-Ring, Calibrator Valve Manifold
22	1621-565-00	Coupling, 1/8 NPT
23	1890-068-00	Filter, Sintered
24	0139-200-00	Valve Block
25	Commercial	Screw, Socket Head, #10-32 X 1/2"
26	Commercial	Lockwasher, Split, #10

5. An O-ring is located in the valve block. Remove it with a plastic or other non-metallic instrument. Do not use metal or any other hard instruments as they can scratch the O-ring and render it useless for vacuum operations.

Inspect the O-ring; dispose if damaged or worn and replace with a new O-ring. If the O-ring is in good condition, clean thoroughly using a clean and dry lint-free cloth.

Important!

Solvents such as acetone or alcohol are destructive to rubber surfaces and should never be used to clean O-rings or other rubber components.

6. Wipe the valve seat with a lint-free cloth. Clean the rubber end plunger and the seal with a lint-free cloth. Coat the rubber end plunger completely with a very thin covering of vacuum grease (Dow Corning High Vacuum grease recommended). The coating should be thin enough so that except for a glossy coat on the seat, the grease is barely visible).
7. Replace the spring into the plunger and the plunger into the valve coil.
8. Coat the O-ring with a thin covering of vacuum grease (as in step 6). Reinstall the O-ring into its valve block seat.
9. Reattach the valve assembly to the valve block, checking for proper orientation. Replace the screws and washers. Reattach wires removed in Step 2 to the proper prongs.

4.3.11 Servicing the Gross Valve

1. Vent the entire system (as per 4.3.4) and turn off power to the unit.
2. The Gross valve is labeled and is mounted near the middle of the valve block (see valve block exploded view in fig. 4-7). Remove the wires from the electrical connectors on the valve coil, noting which wire is connected to each metal prong (For the Gross valve, a yellow wire is connected to the upper prong; a striped wire is connected to the lower prong).

3. Remove the four screws that hold the internal valve mechanism and the valve restrictor plate. Note that there are two pairs of screws, of differing lengths. Two of the screws hold the valve to a block with a sintered metal leak; the other two mount the valve coil to the main valve block (see valve block exploded view in fig. 4-7).
4. Wearing lint-free gloves, remove the two O-rings (the small inner O-ring and the larger outer O-ring) with a plastic tool. Do not use metal or any other hard instruments as they will scratch the O-ring and render it useless for vacuum operations. Wipe each O-ring with a lint-free cloth and check each carefully for nicks, dents or flat spots. Dispose and replace with a new O-ring if damaged or worn. If O-rings are in good condition, clean thoroughly (using a dry, lint-free cloth).
5. Remove the sintered gross leak assembly from the valve coil and inspect. This passage must not be impeded in any way if the MS-50 is to function properly. If visibly blocked or dirty, clean the sintered leak with dry compressed air and wipe its seat with a lint-free cloth.
6. Coat O-rings completely with a very thin covering vacuum grease (Dow Corning High Vacuum grease recommended). The coating should be thin enough so that except for a glossy coat on the seat, the grease is barely visible.
7. Using a lint-free cloth, wipe off any grease or dirt on the O-ring seats.
8. Applying even pressure, replace the O-rings into their respective seats. Make sure that each O-ring is securely mounted; failure to mount the O-ring properly may cause the valve to leak or malfunction.
9. Re-attach the valve coil and restrictor plate with the four screws removed in Step 3. Reattach the electrical connections removed in Step 2.

4.3.12 Servicing the Sniff Valve

1. Vent the entire system (per 4.3.4), then turn off power to the unit.
2. The **Sniff** valve is labeled and mounted on the valve block (see valve block exploded view in fig. 4-7). Remove the wires from the electrical connectors on the valve coil, noting which wire is connected to each metal prong (a yellow wire is connected to the upper prong; a striped wire is connected to the lower prong).
3. Remove the four screws and washers holding the valve coil to the valve block. Remove the valve assembly.
4. Wearing lint-free gloves, gently remove the O-ring with a plastic tool. *Never* use metal (or any other hard instruments); these can scratch the O-ring and O-ring seat, rendering them useless for vacuum operations. Inspect the O-ring; if damaged or worn, dispose and replace with a new O-ring. If O-rings are in good condition, clean thoroughly using a dry, lint-free cloth.
5. Using a lint-free cloth, remove any grease or dirt from the O-ring seat. Coat the O-ring with a very thin covering of vacuum grease (Dow Corning High Vacuum grease recommended). The coating should be thin enough so that, except for a glossy coat on the seat, the grease is barely visible.
7. Applying pressure evenly, replace the O-ring into its seat. Make sure the O-ring is securely mounted; failure to mount the ring properly may cause the valve to leak or malfunction.
8. Reattach the valve coil using the four screws removed in Step 3. Reattach the electrical connections removed in Step 2.

4.3.13 Servicing the Rough Valve

(Refer to fig. 4-8 for an exploded view of the MS-50 Rough valve assembly)

1. Vent the entire system (per 4.3.4) and turn off power to the unit.
2. Remove the four #6-32 x 1 5/8" pan head screws (item 23) from the vacuum cylinder.
3. Pull the cylinder straight back and off of the piston (item 18).
4. Using an adjustable spanner wrench (Vacuum Instrument Part No. 1330-462-00) and a stem nut tool (Vacuum Instrument Part No. 0126-331-00), remove the **stem nut** (item 20) from the piston/bellows assembly.
5. Remove the O-ring (item 19) from the stem nut. Inspect the O-ring; dispose if damaged or worn and replace with a new O-ring. If the O-ring is in good condition, clean thoroughly using a clean and dry lint-free cloth. Apply a very thin layer of vacuum grease to the O-ring and install into the stem nut.
6. Remove the four #14 screws from the **bellows** assembly (item 12). Remove bellows assembly. Remove the bellows O-rings (items 10 and 11). Inspect, clean, and replace as in Step 5.
7. Remove the piston O-ring (item 17). Lubricate the piston O-ring and the inside surface of the vacuum cylinder with Lubriplate multipurpose grease (Vacuum Instrument Part No. 1990-057-00) or equivalent.
8. Reassemble and reinstall the piston/bellows assembly. Replace the stem nut.
9. Slide the cylinder back over the piston and re-attach the four screws removed in Step 2.

Figure 4-8 MS-50 Rough Valve (Exploded View)

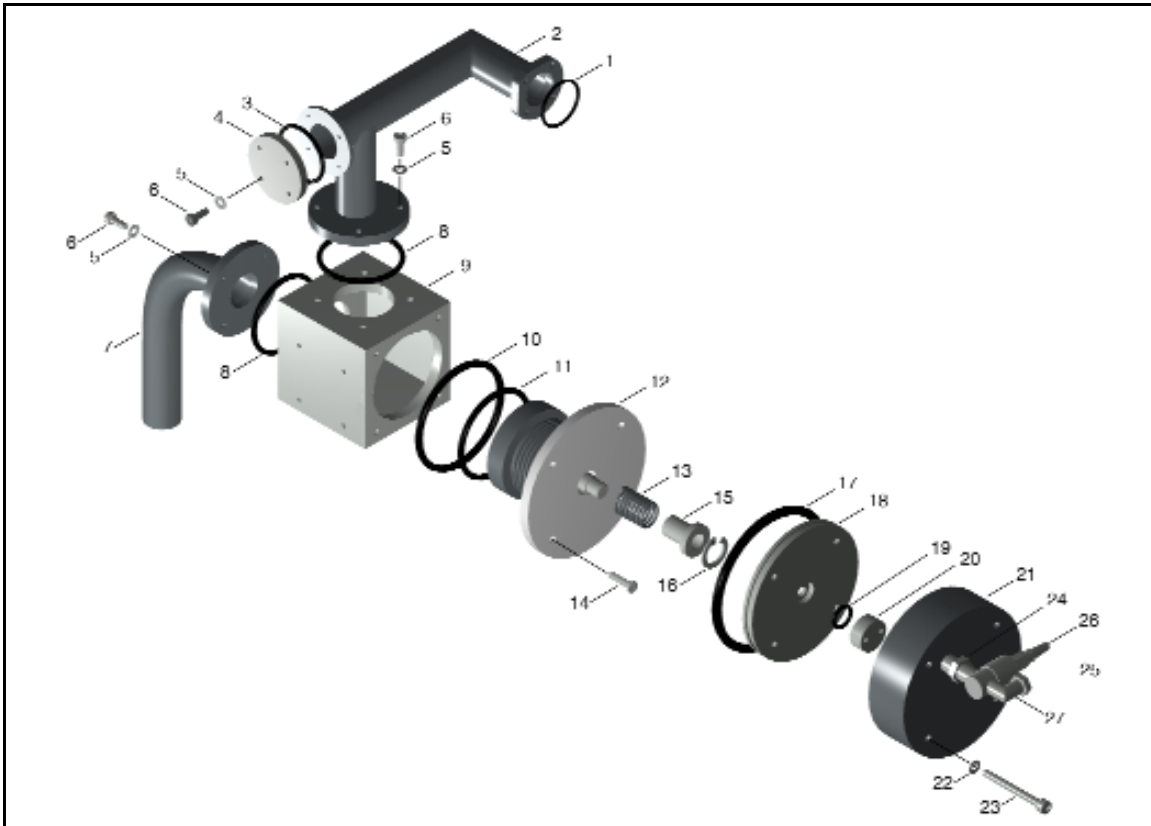

Figure 4-8: MS-50 Rough Valve Components

Item #	VIC P/N	Description
1	0011-025-00	O-Ring, 1 3/16" ID X 1/16" W
2	0139-205-00	Roughing Manifold
3	0016-026-00	O-Ring, 1 1/4" ID X 1/16" W
4	0139-243-00	Side Port Cap
5	Commercial	Lockwasher, Split, #10
6	Commercial	Screw, Socket Head, #10-32 X 7/16"
7	0139-204-00	Roughing Line
8	0011-128-00	O-Ring, 1 1/2" ID X 3/32"W
9	0136-423-00	Rough Valve Block
10	0011-138-00	O-Ring, 2 1/8" ID X 3/32" W
11	0011-222-00	O-Ring, 1 1/2" ID X 1/8" W
12	0135-551-00	Stem, Cap and Bellows Assembly
13	1330-721-00	Spring
14	Commercial	Screw, Flat Head, 1/4-20 X 5/8"
15	1330-722-00	Retaining Ring
17	0011-340-00	O-Ring, 3 3/8" ID X 3/16" W
18	0126-041-00	Piston
19	0011-015-00	O-Ring, 9/16" ID X 1/16" W
20	0126-042-00	Stem Nut
21	0126-049-00	Vacuum Cylinder
22	Commercial	Lockwasher, Split, #6
23	Commercial	Screw, Socket Head, #6-32 X 1 5/8"
24	1620-896-00	Nipple, Reducing, 1/4 MPT X 1/8 MPT
25	0135-105-13	Valve, Rough Control
26	1890-154-00	Filter, Silencer
27	1620-726-00	Elbow, Male, 1/8 MPT X 1/4 Tube

4.3.15 Cleaning the Turbo Pump

Cleaning of this pump must be in accordance with the procedures recommended by the manufacturer. These procedures are detailed in the pump manufacturer's manual that is supplied with the MS-50. For questions regarding servicing the turbo pump, contact the Customer Service Department at Vacuum Instrument.

NOTE:

The turbo pump should only be cleaned in cases of extreme contamination. Under normal circumstances, this component will not require cleaning.

Removing the Turbo Pump for Cleaning:

NOTE:

Note the alignment and orientation of all parts prior to removal. Proper alignment is critical when reinstalling the components removed in this procedure.

1. Vent the vacuum system (per 4.3.4), then turn off power to unit.
2. Remove the unit's front and left side access panels.
3. Disconnect the electrical connection to the turbo pump.
4. Loosen the three (3) claw clamps that secure the turbo pump to the high vacuum manifold and disconnect the two (2) KF16 clamps connecting the unit to the **mass spectrometer source** and the **foreline**.
5. Remove the three (3) claw clamps. Make note of the proper orientation of the pump for reinstallation, then remove the pump from the system.
6. Refer to manufacturer's instructions for cleaning the turbo pump. Pump service should be limited to the cleaning procedure since any additional work performed on the pump may void the warranty.
7. After cleaning, lightly coat the O-ring on the NW63 centering ring with high vacuum grease and reattach the turbo pump to the high vacuum manifold using the three (3) claw clamps.

8. Lightly coat the O-ring on each KF16 centering ring with high vacuum grease before reattaching to the foreline and mass spectrometer source with the KF16 clamps.
9. Reconnect turbo pump electrical connector.

4.4 Components Requiring Calibration

Calibration is necessary when components associated with a measurement function are serviced, repaired or replaced. This section details the calibration procedures for the following components:

- **Test Port and Foreline Pirani Gauges**
- **High Vacuum Gauge**
- **Temperature Sensor**

4.4.1 Test Port Pirani Calibration

If either the Test Port pirani gauge or Circuit Board **A** are replaced, calibration of the gauge becomes necessary.

Before beginning, install a blank plug on the test port and place the MS-50 into **Service** mode.

1. Press the **Ranging** up/down arrow keys until the 10-10 decade is selected.
2. Close all valves except the **Foreline** valve and make sure that the filament is turned **off**.
3. Open the **Rough** valve to begin roughing down the Test Port. When Test Port pressure reaches approximately **10 mTorr**, wait 5 seconds, then open the Direct valve and close the Rough Valve.
4. After allowing time for the pressure to stabilize, adjust potentiometer **R101** (located at the top left of the circuit board **A**) until the test port pressure indicated on the **Service** mode vacuum system schematic (see fig. 4-1) equals two (2) milliTorr.

NOTE:

Be careful not to set R101 too low; while the potentiometer can set the test port pressure lower than 1 mTorr, the Test Port bar graph display is not programmed to indicate values less than 1 mTorr.

5. Close the **Direct** valve. Turn the keyswitch back to **Norm** mode. The test port pirani gauge is now calibrated.

4.4.2 Foreline Pirani Calibration

Before beginning, install a blank plug on the test port and place unit in the MS-50 into **Service** mode.

Important!

The test port pirani must be calibrated prior to calibration of the foreline pirani.

1. Using the **Ranging** up/down arrow keys, set the unit to range downward to the 10⁻⁸ decade (i.e., a range the unit can run in while in Reverse mode).
2. Make sure that all valves except the **Foreline** valve are closed and that the filament is **off**.
3. Open the **Rough** valve. When the test port pressure has pumped down to 100mTorr, open the **Reverse** valve, then close the Rough valve. Wait until test port pressure stabilizes.
4. Make note of the foreline pressure reading. Adjust potentiometer **R79** on circuit board A (near the top left corner of the board) until the current foreline pressure reading displayed on the CRT is the same as the test port pressure.
5. Turn the key-switch back to **Norm** mode. The foreline pirani is now calibrated.

4.4.3 High Vacuum Gauge Calibration

High Vacuum Gauge calibration is necessary any time the source, mass spectrometer or B circuit board are replaced.

WARNING!

High Vacuum Gauge calibration requires removal and replacement of the circuit board B cover. Since potentially lethal voltages are present at circuit board B, extreme caution should be exercised during this procedure!

1. Place the MS-50 into Service mode and turn the filament off. Close all valves except the Foreline valve.
2. Remove the unit's left side access panel. Disconnect the source electrical harness.
3. Open the Vent valve. Install a closed variable leak valve (VIC P/N 0130-568-00) in the test port. Close the Vent valve.
4. Open the Rough valve. When the test port pressure reads 20 mTorr or less, open the Direct valve, then close the Rough valve.
5. Making sure the filament is still turned off, plug in the source electrical harness.
6. While monitoring the test port pressure, slowly open the variable leak. When test port pressure reaches 28 mTorr, turn on the filament.
7. Remove the unit's right side access panel. Remove the cover on circuit board B. Adjust the potentiometer on board B until the high vacuum pressure reading equals 5×10^{-4} Torr.
8. Close the Direct valve. Open the Vent valve and remove the variable leak from the test port. Place a blank plug on the test port and return the MS-50 to Normal mode.

4.4.4 Calibrating the Temperature Sensor

The temperature sensor requires calibration if it is replaced or if circuit board A is replaced.

1. Place the MS-50 into Service mode. Remove the front access panel; the unit's internal calibrator should be clearly visible.
2. Connect a temperature probe to the temperature sensor located on the body of the internal calibrator.

In the event of a broken sensor, the unit will shut down with an error 09, **TEMPERATURE TOO HIGH**. With the power off, the MS50 can still be operational by moving the jumper on the "A" board from position W1 to W2. This is **ONLY A TEMPORARY FIX**. This utilizes a reference potentiometer R61 on the board in place of the defective sensor. While in this mode, temperature correction is disabled. A fixed value of 28 degrees should be displayed when this mode is enabled. This can be adjusted with R61.

NOTE:

The temperature probe should have a resolution of 0.1° Centigrade.

3. From the **Help/Settings Menu** (see 3.6.1), select **Internal Cal.** to display the current internal calibrator temperature.
4. Adjust potentiometer **R53** (located at the bottom right of circuit board A) until the displayed current temperature reading matches the temperature indicated by the temperature probe.

4.5 Circuit Boards

The MS-50 contains four circuit boards that comprise the computer control system for the unit. Circuit board **A** (controlling the unit's computer, logic/sensors, and video display) and circuit board **B** (controlling the unit's mass spectrometer voltage supplies) are mounted within the right side of the MS-50 chassis, and may be serviced by removing the unit's right side access panel. Circuit Board **C** (the user interface board) is located underneath and attached to the User Panel. Circuit Board **D** is the board within the optional handheld remote control unit.



WARNING!

The MS-50 must be turned OFF prior to repair or replacement of any of the circuit boards. When the unit is powered ON, potentially lethal high voltages are continually applied to the circuit boards and other areas within the unit during its operation. Failure to follow this precaution may lead to severe injury or death. Users should contact Vacuum Instrument before attempting to repair or replace circuit boards.

4.6 Servicing the MS-50 Monitor (CRT)

If problems with the MS-50's cathode ray tube monitor are encountered, users should contact the Vacuum Instrument Customer Service Department for further information.

4.7 MS-50 Error Messages

The MS-50 computer continually monitors all system status and operational data. If an error is detected, it will immediately display an error message (and its associated code number) in red at lower left corner of the CRT screen. If the leak detector needs to be shut down, the system computer will do so immediately.

The following table lists potential MS-50 error conditions and the unit's response to them. Included in the table are the probable causes and recommended corrective actions.

Error Code/ Description	System Response	Probable Cause	Corrective Action
<p>ERROR 01: Foreline Maximum Error.</p> <p>Foreline Pressure has exceeded 8,500 milliTorr.</p>	<p>Logo Screen is displayed. System senses high pressure in the foreline region. The unit has switched off the filament, closed all valves except the foreline valve and has shut down the turbo molecular pump. The system will wait 20 seconds and will determine if the pressure in the foreline section has dropped below 100 milli - Torr. If the pressure has not dropped, the system will repeat this procedure ten times. If the pressure is still too high the unit will shut off.</p>	<ol style="list-style-type: none"> 1. Reverse Crossover is set too high 2. Part under test has extremely high gas load 3. Leak in vacuum system 4. Foreline Pirani circuit on A board not calibrated 5. Defective circuit on A board 6. Defective foreline pirani 7. Defective foreline pump 	<ol style="list-style-type: none"> 1. Lower Reverse Crossover (see Section 3.4.4) 2. Lower reverse crossover and increase reverse Rough Close Delay (see Sections 3.4.4, 3.4.9) 3. Locate and repair leak 4. Calibrate foreline pirani circuit on A board (see Section 4.4.2) 5. Replace A Board 6. Replace foreline pirani 7. Replace foreline pump
<p>ERROR 02: Hi-Vac Error</p> <p>1) High-vacuum section pressure higher than 5×10^{-4} Torr</p>	<p>The system has switched off the filament, waited ten seconds and turned the filament back on. If this condition persists, the User should cancel the testing procedure. If the unit is already in the Standby mode, no testing is allowed until pressure drops to allowable level.</p>	<ol style="list-style-type: none"> 1. Direct Crossover Set too high 2. Part under test has high gas load 3. Leak in vacuum system - most likely high vacuum section 4. High vacuum gauge circuit on B Board not calibrated 	<ol style="list-style-type: none"> 1. Lower Direct Crossover (see Section 3.4.5) 2. Test part in Reverse flow mode (see Section 3.4.17) or Lower Direct Crossover (see Section 3.4.5) and increase Direct Crossover Delay (see Section 3.4.11). If testing in Direct mode only, also increase Direct Rough Close Delay (see Section 3.4.10). 3. Locate and repair leak 4. Calibrate High Vacuum gauge circuit on B Board (see Section 4.4.3)

Error Code/ Description	System Response	Probable Cause	Corrective Action
<p>ERROR 04: Auto Zero Error</p> <p>The Leak the User has attempted to "Auto Zero" is too large for the system's Auto Zero function to handle.</p>	<p>The Auto Zero function will not be enabled. To start another test cycle, place the unit in Standby Mode and press the ZERO momentary switch again.</p>	<p>The test object has a leak that is too large for the current test mode</p>	<ol style="list-style-type: none"> 1. Change the test mode <p>Allow the unit to pump away excess helium (while in Standby Ready to Test) mode</p>
<p>ERROR 05: Foreline Test Error</p> <p>The foreline region pressure has exceeded 7,000 milli Torr.</p>	<p>With the exception of the foreline valve, all vacuum system valves that are open will be closed. The unit places itself in "Standby" mode.</p>	<ol style="list-style-type: none"> 1. Reverse Crossover is set too high 2. Part under test has extremely high gas load 3. Leak in vacuum system 4. Foreline Pirani circuit on A Board not calibrated 5. Defective circuit on A board 6. Defective foreline pirani 7. Defective foreline pump 	<ol style="list-style-type: none"> 1. Lower Reverse Crossover (see Section 3.4.4) 2. Lower reverse crossover and increase Reverse Rough Close Delay (see Section 3.4.4 and 3.4.9) 3. Locate and repair leak 4. Calibrate foreline pirani circuit on A Board (see section 4.4.2) 5. Replace A Board 6. Replace foreline pirani 7. Replace foreline pump
<p>ERROR 07: High Voltage Error</p> <p>One or more of the high-voltage supplies on Circuit Board "B" has/have failed.</p>	<p>The system will shut off the filament, shut all valves except the foreline valve and turn off the rough pump. Displays logo screen and waits for 20 seconds. Attempts another restart until error is detected again (will attempt up to 10 times).</p>	<ol style="list-style-type: none"> 1. Short in mass spectrometer source assembly 2. Defective B Board 3. Defective power supply 4. Defective ribbon cable from A to B board 	<ol style="list-style-type: none"> 1. Clean or rebuild source assembly as necessary 2. Replace B Board 3. Replace power supply (Contact Vacuum Instrument Service Dept) 4. Replace A-B Ribbon cable

Error Code/ Description	System Response	Probable Cause	Corrective Action
<p>ERROR 08: Low Filament Error</p> <p>Filament current has dropped below 1 Ampere.</p>	<p>System will keep working, the error will still be displayed on the screen. Leak rate is most likely incorrect. Test should be stopped by the user.</p>	<ol style="list-style-type: none"> 1. The useful life of the filament has expired or the filament is defective 2. Defective B Board 	<ol style="list-style-type: none"> 1. Change to the other filament using the Filament 1/2 key <ol style="list-style-type: none"> 1. a. Replace the filament <p>Note: Always perform a full Tune (see Section 3.3) after replacing filaments</p> 2. Replace B Board
<p>ERROR 09: High Temperature Error</p> <p>Temperature within the unit is too high for the leak detector to function accurately (the temperature sensor reading is >60°C).</p>	<p>(Same as Error 7, except temperature is monitored)</p>	<ol style="list-style-type: none"> 1. The internal ambient temperature (as measured by the calibrator temperature sensor) is above the operating limit of the MS-50 (>50°C) 2. Temperature Sensor is defective 3. Circuit on A Board is not calibrate 4. Defective A Board 	<ol style="list-style-type: none"> 1. Move MS-50 to area with a lower ambient temperature 2. Replace temperature sensor 3. Calibrate temperature sensor circuit on A board (see Section 4.4.4) 4. Replace A board
<p>ERROR 10: Emission Error</p> <p>The filament emission current is below its allowable limit (4.7 mA).</p>	<p>During testing, the system will display the error on the User Panel. The User cannot perform a Calibration Check sequence after this error has occurred.</p>	<ol style="list-style-type: none"> 1. The filament is not properly aligned within the source 2. Defective filament 3. Contaminated source or short in mass spectrometer source assembly 4. Defective B Board 	<ol style="list-style-type: none"> 1. Re-align the filament (see Section 4.3.8) 2. Replace filament (see Section 4.3.8) 3. Clean or rebuild source assembly as required 4. Replace B Board
<p>ERROR 11: PC Remote Error</p> <p>Optional remote computer error.</p>	<p>The system is still usable, however, the remote computer is probably inoperative. To resume testing, place the unit in Standby Mode and press the ZERO momentary switch. Disconnect PC remote if error persists.</p>	<ol style="list-style-type: none"> 1. Improper connection between the MS-50 and the remote PC 2. Defective cable between MS-50 and remote PC 3. Defective remote PC 	<ol style="list-style-type: none"> 1. Re-connect cable between the MS-50 and the remote PC. Verify that cable is RS-232 with null modem. 2. Replace cable between MS-50 and remote PC 3. Repair or replace remote PC

Error Code/ Description	System Response	Probable Cause	Corrective Action
<p>ERROR 13: Rough Time Error</p> <p>Test port pressure cannot be pumped to crossover pressure within the allotted time (50 seconds to set below 10,000 mTor, 2 minutes to get below crossover). This error will only occur when the unit is performing a Calibration Check or during the Tune procedure.</p>	<p>The system will abort the Calibration Check or the Tune procedure. In order to resume testing or to “re-check” the unit, place the unit in Standby Mode and press the ZERO momentary switch.</p>	<ol style="list-style-type: none"> 1. Test port is not properly sealed. 2. Dirty or defective test port o-ring 3. Leak in vacuum system 4. a. Test port pirani circuit on A board is not calibrated 5. Contaminated rough pump oil 6. Defective test port pirani 7. Defective rough pump 	<ol style="list-style-type: none"> 1. Verify that test port QC nut is sufficiently tight 1. a. Verify that test cup is properly closed, if applicable. 2. Verify that test port o-ring is clean and properly greased 2. a. Inspect test port o-ring for damage and replace if necessary 3. Locate and repair leak 4. Calibrate test port pirani circuit on A board (see Section 4.4.1) 5. Change rough pump oil (see Section 4.2.5) 6. Replace test port pirani 7. Replace rough pump
<p>ERROR 18 Printer Error</p> <p>Optional printer is not responding.</p>	<p>The system will display the error. All other functions will continue.</p>	<ol style="list-style-type: none"> 1. Printer not switched on 2. No paper in printer 3. Defective cable between MS-50 and printer 4. Cable not securely attached to the printer or the MS-50 5. Defective printer 	<ol style="list-style-type: none"> 1. Switch printer On 2. Add paper to printer 3. Replace printer cable 4. Reattach printer cable 5. Repair or replace printer

Error Code/ Description	System Response	Probable Cause	Corrective Action
<p>ERROR 22: Temperature Low Error</p> <p>The temperature sensor indicates a reading below 10°C.</p>	<p>(Same as Error 9)</p>	<ol style="list-style-type: none"> 1. The ambient temperature is below the operating limit of the MS-50 (<10°C) 2. Temperature Sensor is defective 3. Temperature sensor circuit on A Board is not calibrated 4. Defective A board 	<ol style="list-style-type: none"> 1. Move MS-50 to area with higher ambient temperature 2. Replace temperature sensor 3. Calibrate temperature sensor circuit on A board (see Section 4.4.4) 4. Replace A board
<p>ERROR 23: Can't Peak Error</p> <p>During a Tune cycle, while the unit scans the voltages emitted by the source, the unit cannot identify a leak rate peak (indicating helium).</p>	<p>System aborts the Tune cycle. In order to resume testing or to attempt to re-tune the unit, place the unit in Standby Mode and press the ZERO momentary switch.</p>	<ol style="list-style-type: none"> 1. Collector wiring harness not properly connected 2. Defective collector 3. Defective A Board 4. Mass spectrometer magnets not properly installed 	<ol style="list-style-type: none"> 1. Re-connect collector wiring harness 2. Replace collector 3. Replace A board 4. Verify proper magnet alignment and polarity
<p>ERROR 24: High Gain Error</p> <p>At the end of a Tune cycle or a Calibration function, the unit cannot supply a "gain" (either "G2" or "G3") within system limits (limits are between 1.0 and 10.0)</p>	<p>The system will display the error on the screen. In order to resume testing or to attempt to re-tune or re-check the unit, place the unit in Standby Mode and press the ZERO momentary switch.</p>	<ol style="list-style-type: none"> 1. Contaminated mass spectrometer tube 2. Collector wiring harness not properly connected 3. Defective collector 4. Defective A Board 5. Mass spectrometer magnets not properly installed 	<ol style="list-style-type: none"> 1. Clean mass spectrometer tube (see Section 4.3.7) 2. Re-connect collector wiring harness 3. Replace collector 4. Replace A board 5. Verify proper magnet alignment and polarity

Error Code/ Description	System Response	Probable Cause	Corrective Action
<p>ERROR 26: Turbo Fail Error</p> <p>The system has detected an error with the turbo-molecular pump system</p>	<p>Shuts off the filament, shut all valves except the foreline valve, and turn off the rough pump. Monitors Turbo pump status. Displays logo screen and waits for 20 seconds. Attempts another restart until error is detected again (will attempt up to 10 times).</p>	<ol style="list-style-type: none"> 1. Defective turbo pump power supply 2. Defective turbo pump 	<ol style="list-style-type: none"> 1. Replace turbo pump power supply 2. Replace turbo pump
<p>ERROR 30: Handheld Remote Error</p> <p>Transmission error between the handheld remote and the main unit.</p>	<p>The handheld remote functions are inoperative. To resume the test cycle, place the unit in Standby Mode and press the ZERO momentary switch.</p>	<ol style="list-style-type: none"> 1. Handheld remote cable is not properly connected 2. Defective handheld remote cable 3. Defective handheld remote 4. Defective A Board 	<ol style="list-style-type: none"> 1. Re-connect handheld remote cable 2. Replace handheld remote cable 3. Replace handheld remote 4. Replace A Board
<p>33 Repeller Fail</p> <p>The system has detected an error involving the repeller inside the source</p>	<p>Displays the error on the screen. User should stop testing and repair the repeller. Leak rate is most likely incorrect.</p>	<ol style="list-style-type: none"> 1. Source disconnected 2. Faulty repeller wire in source cable 3. Repeller failed 	<ol style="list-style-type: none"> 1. Reconnect source 2. Replace source cable harness 3. Replace source

Recommended Spare Parts for the MS-50:

Mass Spectrometer	0139-010-00
Source Assembly	0137-014-00
Source Rebuild Kit	0126-186-00
Collector Assembly	0136-051-00
Filament Kit	0103-141-01
Rough Pump	
Pump Assembly; 115V	0139-426-00
Pump Assembly; 230V	0139-426-01
Pump Assembly; 100V	0139-426-02
Oil - 1 Liter	1990-900-01
Exhaust Filter Cartridge	0131-709-00
Foreline Pump	
Forepump Assembly; 115V	0139-416-00
Forepump Assembly; 230V	0139-416-01
Forepump Assembly; 100V	0139-416-02
Oil - 1 Liter	1990-900-01
Exhaust Filter Cartridge	0131-709-00
Turbo Pump	
Turbo Pump	1660-253-00
Power Supply, Turbo Pump	1660-255-00
Centering Ring, NW63	1621-150-00
Cartridge	1660-262-00
Valves	
Calibrator Valve	1890-288-00
Direct Valve	0137-120-02
Gross Valve	1890-285-00
Gross Leak Assembly	0139-209-00

Reverse Valve	0137-120-00
Sniff Valve	1890-287-00
Vent Valve	0137-120-02
Foreline Valve	0139-105-15
Rough Valve Control Solenoid	0135-105-13
Rough Valve Stem, Cap & Bellows Assembly	0135-551-00

Pirani Gauge 0137-702-00
(Test Port and Foreline)

Circuit Boards

A Board (Logic & Valve Drivers)	8319-211-00
B Board (Mass Spec)	8317-212-00
C Board (User)	8319-213-00
Switch Panel	8319-216-00
Computer Board	8319-701-00
Video Driver Board	900293
Computer Battery	8317-234-00
Temperature Sensor	8315-226-00

Maintenance Kit 0139-801-00

Includes:

Filaments	0103-141-01
Mechanical Pump	0131-709-00
Exhaust Cartridge	
Filter, Sintered, 1/4 NPT	1890-068-00
Filter, Sintered, 1/8 NPT	1890-154-00
Inlet Filter	1890-179-00
Air Filter	1180-245-00
Gross Leak Assembly	0139-209-00
High Vacuum Grease	1990-352-00
Mechanical Pump Oil	1990-900-01
Cartridge, Turbo Pump	1660-262-00
Gross Leak Assembly	0139-209-00
LED, 6 chip, green	877230
Fuse, 3A, SloBlo	869030

O-Ring Kit -MS-50	0139-802-00
Tool Kit	0137-806-00
Spanner Wrench	1330-462-00
Stem Nut Tool	0126-331-00
Grease, Lubricant	1990-057-00
Source Rebuild Kit	0126-186-00

Source Rebuilding Kit 0126-186-00

Includes:

Filament Clamp	0103-146-00
Filament Block	0103-145-00
Insulator	0103-126-00
Insulator for MS-40 & MS-50	0137-126-00
Spacer	0103-125-00
Spacer	0103-124-00
Repeller	0120-284-00
Focus Plate	0120-057-00
Shield Assembly	0120-055-00

Parts List for MS-50 Overall Assembly:

Item #	VIC Part #	Description
1	900292	CRT, 9" Color VGA
2	0135-470-00	Trim Ring
3	0139-020-00	Valve Block Assembly
4	8319-216-00	Switch Panel
5	8319-213-00	User Panel
6	900159	Speaker
7	0137-015-00	Calibrator Assembly
8	1660-255-00	Power Supply, Turbo Pump
9	0139-206-00	Foreline Manifold
10	0139-246-00	Fan Filter Bracket
11	1180-248-00	Fan, System
12	1180-245-00	Filter
13	1890-366-00	Ballast Cylinder
14	0139-426-00	Roughing Pump Assembly, 115V
	0139-426-01	Roughing Pump Assembly, 230V
	0139-426-02	Roughing Pump Assembly, 100V
15	0139-416-00	Foreline Pump Assembly, 115V
	0139-416-01	Foreline Pump Assembly, 230V
	0139-416-02	Foreline Pump Assembly, 100V
16	0136-025-00	Rough Valve Assembly
17	0139-204-00	Roughing Line
18	0139-205-00	Rough Manifold
19	1660-104-00	Pump Exhaust Filter
20	1660-253-00	Turbo Pump
21	0139-214-00	High Vacuum Manifold
22	8317-700-00	Power Supply, Main
23	1180-129-00	Fan, Mass Spectrometer
24	0139-010-00	Mass Spectrometer Assembly

MS-50 Overall Assembly

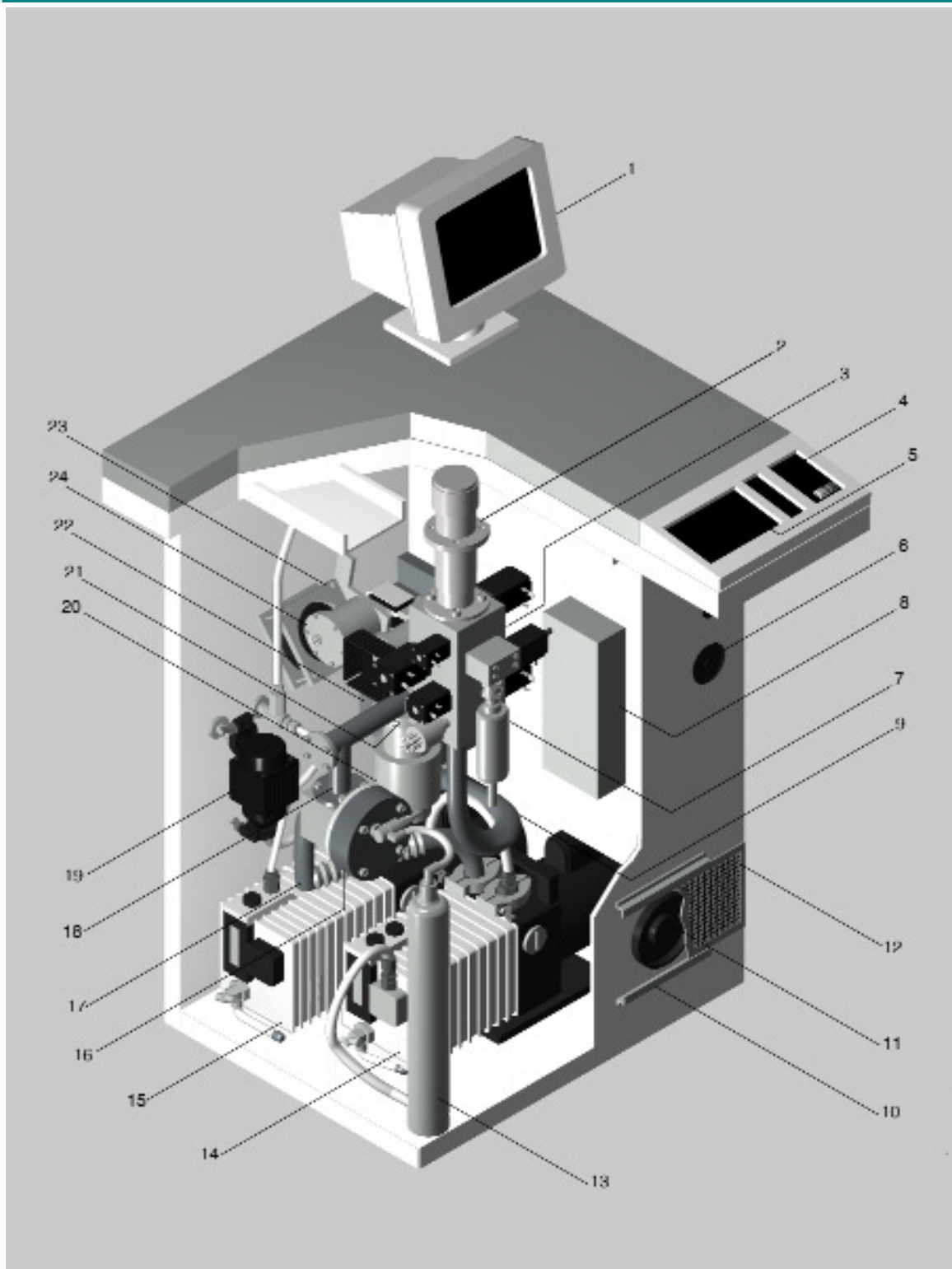

Parts List for MS-50 Vacuum System Assembly

Item #	VIC Part #	Description
1	0137-015-00	Calibrator Assembly
2	Commercial	Screw, Socket Head, #8-32 x 1 3/8
3	0011-014-00	O-Ring, 1/2" ID x 1/16" W
4	0139-020-00	Valve Block Assembly
5	0139-010-00	Mass Spectrometer Assembly
6	0137-232-00	Heat-sink
7	1621-231-12	Centering Ring Assembly, KF16
8	1621-239-02	Clamp, KF16
9	0139-214-00	High Vacuum Manifold
10	1621-150-00	Centering Ring, NW63
11	1331-527-00	Double Claw Clamp (3)
12	1660-253-00	Turbo Pump
13	Commercial	Screw, Socket Head, #10-32 x 1/2"
14	Commercial	Lock-washer, Split, #10
15	0011-128-00	O-Ring, 1 1/2" ID x 3/32" W
16	0139-206-00	Foreline Manifold
17	0011-125-00	O-Ring, 1 5/16" ID x 3/32" W
18	0011-025-00	O-Ring, 1 3/16" ID x 1/16" W
19	0139-205-00	Roughing Manifold
20	0139-243-00	Side Port Cap
21	0136-025-00	Rough Valve Assembly
22	0139-204-00	Roughing Line

MS-50 Vacuum System Assembly

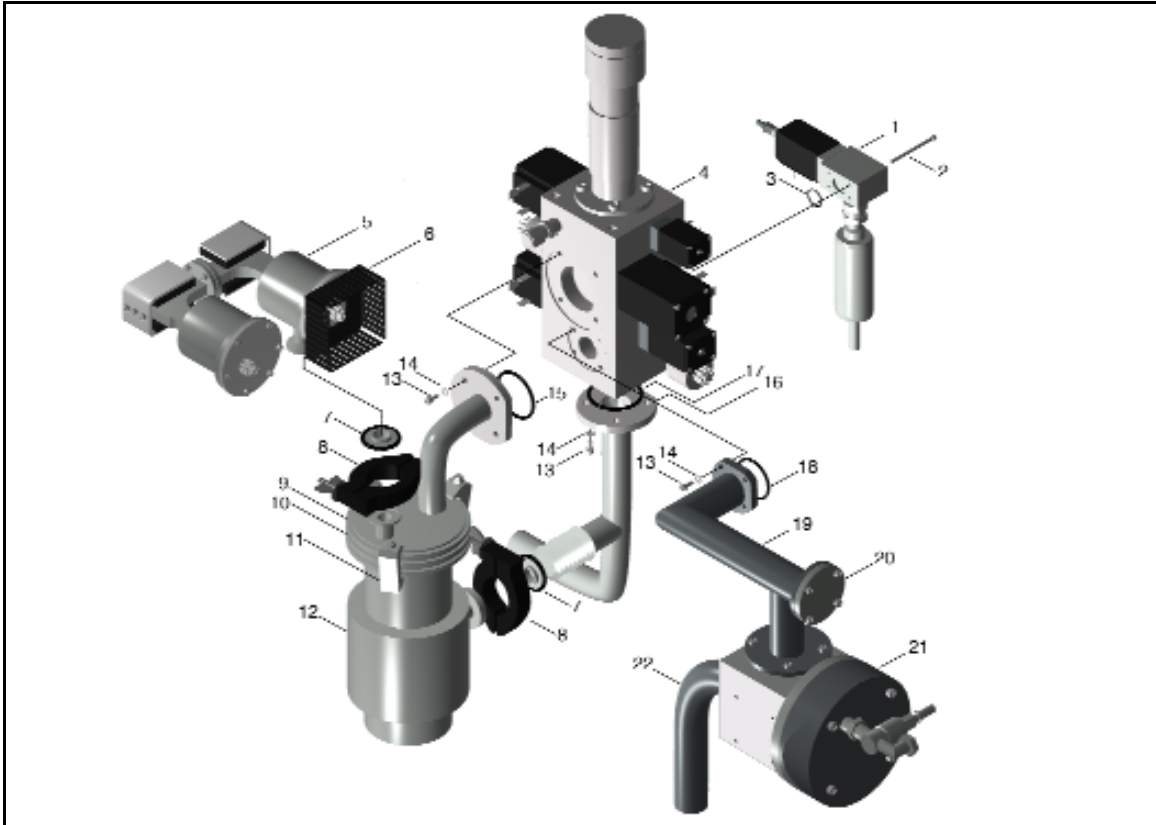

Glossary of Terms Used in Leak Detection

Background

In the case of a leak detector, the spurious output, expressed in suitable terms, due to the response to other gases than the actual gas being used for probing. The background may be inherent in the detector, or accidental.

Gross Leak

A leak which exhibits a leak rate in the range of 10^{-4} to 1 atm cc/sec or higher.

Fine Leak

A leak that exhibits a leak rate in the range of 10^{-5} to 10^{-11} atm cc/sec or lower.

Flooded System

A system that, while being leak tested under vacuum, becomes so filled with tracer gas as to make further leak detection by means of a probe impractical.

Helium Drift

In the case of leak detection with a helium probe, the drift of helium to a leak or permeable gasket located at a point sufficiently remote from the end of the probe to mislead the operator into suspecting the area near the probe.

Hood Test

An overall test in which an object under vacuum test is enclosed by a "hood" which is filled with tracer gas so as to subject all parts of the test object to examination at one time.

Ion Source

That part of a spectrometer tube in which tracer gas is ionized prior to being detected.

Isolation Test

A method of determining whether a leak is present in a system, or of obtaining an estimate of its magnitude, by observing the rate of rise of pressure in the evacuated system when the system is isolated from the pump. Also called *rate of rise test*.

Leak

In vacuum technology a hole, or porosity, in the wall of an enclosure capable of passing gas from one side of the wall to the other under action of a pressure or concentration differential existing across the wall.

Leak Detector

A device for detecting and locating leaks, and indicating the magnitude thereof.

Leak Rate

In leak detection practice *leak rate* is defined as the rate of flow (in pressure-volume units per unit time) through a leak with gas at a specified high pressure (usually atmospheric pressure) on the inlet side and gas at a pressure on the exit side that is low enough to have negligible effect on the rate of flow.

Leak Standard (Calibrator)

- a. A device which permits leakage through it, at a specified rate, of a specified gas, with atmospheric pressure at one end of the device and a pressure on the other side sufficiently low to have negligible effect on the leak rate.
- b. A capillary or porous wall leak, usually in a glass or metal tube, whose dimensions have been adjusted to give a conductance within specified limits for a specified gas at a standard reference temperature with specified inlet and exit pressures. Standard leaks for attaching to vacuum test manifolds with air at atmospheric pressure exposed to the inlet are usually protected by filters to avoid clogging by dust particles. Standard leaks for calibrating mass spectrometers are usually fused to a glass reservoir containing the specified gas at a known high pressure.
- c. A device providing a known throughput into a vacuum system. Also referred to as a *Calibrated Leak*.

Masking

The covering of a section of a test object so as to prevent tracer gas from entering leaks that may exist in the covered section.

Mass Spectrometer Leak Detector

A mass spectrometer adjusted to respond only to tracer gas. Helium is commonly used as the tracer gas, and thus the instrument is normally referred to as a *helium leak detector*.

Minimum Detectable Leak

- a. The size of the smallest leak, expressed in terms of mass flow per unit time that can be unambiguously detected by a leak detector in the presence of noise and background.

- b. The product of the minimum detectable pressure change and the pumping speed at the detector

Minimum Detectable Pressure Change

The pressure producing an indication of three times the noise level.

Noise Level

In the case of a leak detector, the spurious output, expressed in suitable terms, exhibited by the detector in the absence of an output due to tracer gas.

Pressure Testing

A leak detecting procedure in which tracer gas is introduced under pressure into the enclosure under examination, and detected as it is emitted from a leak.

Probe

A tube having a fine opening at one end, used for directing a stream of tracer gas.

Probe Gas

A tracer gas that is issued from a more-or-less fine orifice so as to impinge on a restricted test area.

Probe Test

A leak test in which the tracer gas is applied by means of a probe (see below) so that the area covered by the tracer gas is localized. This enables the individual leaks to be located.

Sampling Probe

A device used in pressure testing and so designed as to collect tracer gas from a restricted area of the test object and feed it to the leak detector. Also called *Pressure Probe* or *Sniffer*.

Soap Bubble Test

A type of pressure testing in which the tracer gas is detected by bubbles formed in a layer of soap solution applied to the surface of the test object.

Spectrometer Tube

The sensing element of a mass spectrometer leak detector.

Tracer Gas

A gas which, passing through a leak, can then be detected by a specific leak detector and thus disclose the presence of a leak. Also called *search gas*.

Vacuum Testing

A leak detecting procedure in which the enclosure under examination is evacuated, the tracer gas applied to the outside surface of the enclosure, and the gas is detected after entering the enclosure.

Unit Conversions

The following tables are provided for easy conversions of values between commonly used units of pressure and leak rate:

- **TABLE A:** **Pressure Conversion Chart.**
- **TABLE B** **Leak Rate Conversion Chart.**

TABLE A

PRESSURE CONVERSION CHART

TO	ATM	PSI	TORR	MICRON	PASCAL(0 °C)	mm Hg (32 ° F)	in Hg (32 ° F)	in Hg (60 ° F)	in H2O	DYNE/cm ²	BAR	MILLIBAR
ATM	1	14.7	760	7.6X10 ⁵	1.01X10 ⁵	760	29.92	30.01	407	1.01X10 ⁶	1.01	1.01X10 ³
PSI	6.8 X 10 ⁻²	1	5.17X 10 ¹	5.17X10 ⁻²	6.89X10 ³	5.17X1 0 ¹	2.04	2.04	27.71	6.89X10 ⁴	6.89X10 ⁻²	6.89X10 ¹
TORR	1.32X10 ⁻³	1.93X10 ⁻²	1	1.0X10 ³	1.33X10 ²	1.0	3.94X10 ⁻²	3.95X1 0 ⁻²	5.36X 10 ⁻¹	1.33X10 ³	1.33X10 ⁻³	1.33
MICRON	1.32X10 ⁻⁶	1.93X10 ⁻⁵	1.0X1 0 ³	1	1.33X10 ⁻¹	1.0X10 ⁻³	3.94X10 ⁻⁵	3.95X1 0 ⁻⁵	5.36X10 ⁻⁴	1.33	1.33X10 ⁻⁶	1.33X10 ⁻³
PASCAL	9.87X10 ⁻⁶	1.45X10 ⁻⁴	7.5X1 0 ⁻³	7.5	1	7.5X10 ⁻³	2.95X10 ⁻⁴	2.96X1 0 ⁻⁴	4.02X10 ⁻³	10	1.0X10 ⁻⁵	1.0X10 ⁻²
mm Hg (0°C)	1.32X10 ⁻³	1.93X10 ⁻²	1.0	1.0X10 ³	1.33X10 ²	1	3.94X10 ⁻²	3.95X1 0 ⁻²	5.36X10 ⁻¹	1.33X10 ³	1.33X10 ⁻³	1.33
in Hg (32°F)	3.34X10 ⁻²	4.91X10 ⁻¹	2.54X 10 ¹	2.54X10 ⁴	3.39X10 ³	2.54X1 0 ¹	1	1.00	1.36X 10 ¹	3.39X10 ⁴	3.39X10 ⁻²	3.39X10 ¹
in Hg (60°F)	3.33X10 ⁻²	4.90X10 ⁻¹	2.53X 10 ¹	2.53X10 ⁴	3.38X10 ³	2.53X1 0 ¹	9.97X10 ⁻¹	1	1.36X 10 ¹	3.38X10 ⁴	3.38X10 ⁻²	3.38X10
in H2O (60° F)	2.46X10 ⁻³	3.61X10 ⁻²	1.87	1.87X10 ³	2.49X10 ²	1.87	7.35X10 ⁻²	7.37X1 0 ⁻²	1	2.49X10 ³	2.49X10 ⁻³	2.49
DYNE / cm ²	9.87X10 ⁻⁷	1.45X10 ⁻⁵	7.50X 10 ⁴	7.5X10 ⁻¹	0.1	7.5X10 ⁻⁴	2.95X10 ⁻⁵	2.96X1 0 ⁻⁵	4.02X10 ⁻⁴	1	1.0X10 ⁻⁵	1.0X10 ⁻³
BAR	9.87X10 ⁻¹	1.45X10 ¹	7.52X 10 ²	7.5X10 ⁵	1.0X10 ⁵	7.5X10 ²	2.95X10 ¹	2.96X1 0 ⁻¹	4.02X10 ⁻²	1.0X10 ⁶	1	1.0X10 ³
MILLIBAR	9.87X10 ⁻⁴	1.45X10 ⁻²	7.5X1 0 ⁰	7.5X10 ²	1.0X10 ²	7.5X10 ⁻¹	2.95X10 ⁻²	2.96X1 0 ⁻²	4.02X10 ⁻¹	1.0X10 ³	1.0X10 ⁻³	1

TABLE B

LEAK RATE CONVERSION CHART

FROM TO	Std cm ³ /s	Pa M ³ /s	Pa L/s	Mbar L/s	Torr l/s	Kg Moles/s	Air Molecules/s	Air oz/yr	Air mg/s
Std cm ³ /s	1	0.10	101.33	1.01	0.76	4.46x10 ⁻⁸	2.69x10 ¹⁹	1.44x10 ³	1.29
Pa M ³ /s	9.87	1	1.00x10 ³	10.00	7.50	4.40x10 ⁻⁷	2.65x10 ²⁰	1.42x10 ⁴	12.75
Pa L/s	9.87x10 ⁻³	1.00x10 ⁻³	1	0.01	7.50x10 ⁻³	4.40x10 ⁻¹⁰	2.65x10 ¹⁷	14.19	1.28x10 ⁻²
Mbar L/s	0.99	0.10	100.00	1	0.75	4.40x10 ⁻⁸	2.65x10 ¹⁹	1.42x10 ³	1.28
Torr l/s	1.32	0.13	133.32	1.33	1	5.87x10 ⁻⁸	3.54x10 ¹⁹	1.89x10 ³	1.70
Kg Moles/s	2.24x10 ⁻⁷	2.27x10 ⁶	2.27x10 ⁹	2.27x10 ⁷	1.70x10 ⁷	1	6.02x10 ²⁶	3.22x10 ¹⁰	2.90x10 ⁷
Air Molecules/s	3.72x10 ⁻²⁰	3.77x10 ⁻²¹	3.77x10 ⁻¹⁸	3.77x10 ⁻²⁰	2.83x10 ⁻²⁰	1.66x10 ⁻²⁷	1	5.35x10 ⁻¹⁷	4.81x10 ⁻²⁰
Air oz/yr	6.96x10 ⁻⁴	7.05x10 ⁻⁵	7.05x10 ⁻²	7.05x10 ⁻⁴	5.29x10 ⁻⁴	3.10x10 ⁻¹¹	1.87x10 ¹⁶	1	8.99x10 ⁻⁴
Air mg/s	0.77	7.84x10 ⁻²	78.41	0.78	0.59	3.45x10 ⁻⁸	2.08x10 ¹⁹	1.11x10 ³	1

Introduction

The following paragraphs are extracted, with permission of the American Vacuum Society, from AVS Standards used in defining and testing the operation of mass spectrometer leak detectors. They have been selected because of their application in the testing of all VIC leak detectors. Copies of complete AVS Standard 2.1 (Calibration of Leak Detectors of the Mass Spectrometer Type) and AVS Standard 2.3 (Procedure for the Calibration of Gas Analyzers of the Mass Spectrometry Type) are available by writing to Vacuum Instrument Corporation.

© Copyrights 1972, 1973 by the American Vacuum Society

Standards of the American Vacuum Society for the Testing of Mass Spectrometer Leak Detectors

AVS Standard 2.1, Section 3.1

3.1 Background

3.1.1 General

In general, background is the total spurious indication given by the leak detector without injected search gas. Background can originate in either the mass spectrometer tube or the associated electric and electronic circuitry, or both. (Frequently, the term is used to refer specifically to the indication due to ions other than those produced from injected search gas).

3.1.2 Drift

The relatively slow change in the background. The significant parameter is the maximum drift measured in a specified period of time.

3.1.3 Noise

The relatively rapid changes in the background. The significant parameter is the noise measured in a specified period of time.

3.1.4 Helium Background

Background due to helium released from the walls of the leak detector or leak detection system.

3.4 Leaks

3.4.1 Leak (n)

In vacuum technology, a hole, porosity, permeable element, or other structure in the wall of an enclosure capable of passing gas from one side of the wall to the other under the action of a pressure or concentration difference existing across the wall. Also, a device which can be used to introduce gas into an evacuated system.

3.4.1.1 Channel Leak

A leak, which consists of one or more discrete passages that, may be ideally treated as long capillaries.

3.4.1.2 Membrane Leak

A leak which permits gas flow by permeation of the gas through a non-porous wall. For helium, this wall may be of glass, quartz, or other suitable material.

3.4.1.3 Molecular Leak

A leak through which the mass rate of flow is substantially proportional to the reciprocal of the square root of the molecular weight of the flowing gas.

3.4.1.4 Viscous Leak

A leak through which the mass rate of flow is substantially proportional to the reciprocal of the viscosity of the leak.

3.4.2 Calibrated Leak

A leak device, which provides a known mass rate of flow for, a specified gas under specific conditions.

3.4.3 Standard Leak

A calibrated leak for which the rate of leakage is known under standard conditions, namely $23 \pm 3^\circ\text{C}$, a pressure of 760 Torr $\pm 5\%$ at one end of the leak, and a pressure at the other end so low as to have a negligible effect on the leak rate.

3.4.4 Virtual Leak

The semblance of a leak due to the evolution of gas or vapor within a system.

3.5 Leak Rates

3.5.1 Leak Rate

The mass rate (also called throughput; differentiated from volume rate of flow (liters/sec) also called “pumping speed”), in Torr liters/sec (or Pa m³/sec) at which a specified gas passes through a leak under specific conditions.

3.5.2 Standard Air Leak Rate

The mass rate of flow, through a leak, of atmospheric air of dew point less than -25°C under standard conditions specified as follows: the inlet pressure shall be 760 Torr ±5%, the outlet pressure shall be less than 10 Torr and the temperature shall be 23±3°C.

3.5.3 Equivalent Standard Air Leak Rate

Short-path leaks having standard air leak rates less than 10⁻⁶ to 10⁻⁷ Torr liters/sec (10⁻⁷ to 10⁻⁸ Pa m³/sec) are of the molecular type (see Section 3.4.1.3). Consequently, helium (mol. wt 4) passes through such leaks more rapidly than air (mol. wt 29) and a given flow rate of helium corresponds to a smaller flow rate of air. In this recommendation, helium flow is measured and the “equivalent standard air leak rate” is taken as (4/29)^{1/2}=0.37 times the helium leak rate under standard conditions. (See Sec. 3.5.2).

3.8 Sensitivity Terms

3.8.1 Sensitivity

The sensitivity of a device is the change in output of the device divided by the change in input, which caused the response.

3.8.2 Minimum Detectable Signal

An output signal due to incoming search gas that is equal in magnitude to the sum of the noise and the drift.

3.8.3 Minimum Detectable Leak**(or Minimum Detectable Leak Rate)**

The smallest leak, as specified by its standard air leak rate, that can be detected unambiguously by a given leak detector. The minimum detectable leak rate depends on a number of factors. One of the purposes of this Standard is to describe practical procedures for determining minimum detectable leak rate, taking into account background, volume rate of flow (pumping speed), and time factor.

3.8.4 Minimum Detectable Concentration Ratio

The smallest concentration ratio of a given search gas in an air mixture that can be detected unambiguously by a given leak detector when the mixture is fed to the detector at such a rate as to raise the pressure in the instrument to some optimum high value. In this Standard, the minimum detectable leak rate is calculated - by a somewhat arbitrary procedure - from observations of the response of leak detector to a helium-air mixture of known helium concentration ratio.

5. Test Procedure Minimum Detectable Leak**5.1 Drift and Noise Observation****5.1.1**

The output of the leak detector is connected to the recorder, the leak detector being at its maximum sensitivity setting and the inlet valve closed.

5.1.2

The leak detector backing-off (or zero) control is adjusted so that the recorder reading is approximately 50% of full scale, the filament being on.

5.1.3

The output is recorded for 20 min. or until the output has reached full scale, for positive drift, or zero, for negative drift.

5.1.4

Draw a series of line segments intersecting the curve recorded in Sec. 5.1.3, the lines to be drawn at 1-min. intervals at right angles to the time axis (abscissa) of the chart, and to commence at the point where the procedure of Sec. 5.1.3 is started. The lines so drawn will be called the "1 - min lines."

Draw straight-line approximations for each segment of the curve between adjacent 1-min lines.

5.2 Drift and Noise Determination

5.2.1

Examine the straight-line approximations of Sec. 5.1.4 to determine that 1-min segment of the output curve having the greatest slope. This greatest slope is measured in scale divisions per minute and is called the *drift*. If the greatest slope is less than the scale divisions corresponding to 2% of full scale of the recorder, the total (absolute) change in output over the 20-min period is determined. The total change is divided by 20 is then called the drift.

5.2.2

For each 1 - min segment of the curve, determine the maximum (absolute) deviation of the recorded curve from the straight-line approximation.

5.2.3

The average of these maximum deviations, multiplied by 2, is called the noise (scale divisions).

Note: *In determining the noise, neglect any large deviation (spike) which occurs less frequently than once in any 5-min interval.*

5.3 Minimum Detectable Signal

The minimum detectable signal is taken to be equal to the sum of the absolute values of the drift and of the noise. It should be measured in scale divisions. If the sum is less than the scale divisions corresponding to 2% of full scale, then the scale divisions corresponding to 2% of full scale is called the minimum detectable signal.

5.4 Sensitivity Determination

5.4.1 Arrangement of Apparatus

The leak detector is connected to an auxiliary system. (Frequently, the auxiliary system is included with the leak detector as an integral part there of).

The system should contain a minimum of rubber or other polymeric surfaces. Preferably, such surfaces should consist only of the exposed surfaces of an O-ring or O-rings. Accordingly, the “Leak Isolation Valve” should preferably be of all-metal construction, but in any case should not act as a significant source of adsorbed or absorbed helium.

5.4.2 Spurious Signal Correction

Note: *This determination requires the use of the small-calibrated leak. If the calibrated leak has its own integral valve, and the leak and valve are all-metal construction (except perhaps for the membrane in a membrane-type leak), Sec. 5.4.2 may be omitted from the procedure.*

5.4.2.1

A metal plug is connected to the leak detector

5.4.2.2

The output is zeroed, with the filament on.

5.4.2.3

The leak isolation valve is opened.

5.4.2.4

The pump valve is opened. (**Note:** *For its safety, the filament of the mass spectrometer tube may be turned off at this point.*)

5.4.2.5

When the atmospheric air present between the plug and the inlet valve has been evacuated, the pump valve is closed.

5.4.2.6

The inlet valve is opened promptly, but gradually. The pressure in the leak detector is allowed to reach a steady value, showing no observable change in a 1-min period.

5.4.2.7

Turn on filament of mass spectrometer tube if it is not on.

5.4.2.8

When the output has reached a steady value, but in any case not longer than 3 min after Sec. 5.4.2.6 the output reading is noted. If the leak detector has been set at reduced sensitivity, the reading should be converted to equivalent scale divisions for full-sensitivity setting.

5.4.2.9

Close the leak isolation valve as rapidly as feasible.

5.4.2.10

Note the output reading 10 sec after closing the isolation valve. As in 5.4.2.8, convert the reading if necessary.

5.4.2.11

Subtract the reading noted in 5.4.2.10 from that noted in 5.4.2.8. If the difference is negative, it is to be considered equal to zero. The difference will be called the "spurious-signal correction" and will be applied in Sec. 5.4.3.14.

5.4.2.12

Close the inlet valve.

5.4.2.13

Open the vent valve.

5.4.2.14

Remove only the plug from the inlet line; all connections are to remain in place.

5.4.2.15

Close the vent valve.

5.4.3. Sensitivity**5.4.3.1**

Connect the all-metal leak to the leak detector. However, if the procedure of 5.4.2 was necessary, the small-calibrated leak is put in place of the plug removed in 5.4.2.14 above, the leak being inserted the same distance into the connection as the plug had been.

5.4.3.2

The output is zeroed with the filament on.

5.4.3.3

The leak isolation valve is opened.

5.4.3.4

The pump valve is opened.

5.4.3.5

Helium at 760 Torr +5% pressure is applied to the leak. If the leak has its own supply of helium, this step is omitted. (Note: the filament of the mass spectrometer tube may be turned off before Sec. 5.4.3.6.)

5.4.3.6

When the atmospheric air present between the calibrated leak and the leak detector has been evacuated, the pump valve is closed.

5.4.3.7

The inlet valve is opened promptly after Sec. 5.4.3.6. The pressure in the leak detector is allowed to reach a steady value, showing no observable change in 1 min.

5.4.3.8

Turn on filament of mass spectrometer tube if it is not on.

5.4.3.9

At this point it may be necessary to change the sensitivity setting. When the output signal has reached a steady value, showing a change in 1 min, which is not greater than the drift (as corrected for the sensitivity setting), the output reading in scale divisions is noted. If the leak detector has been set at reduced sensitivity, the reading should be converted to the equivalent scale divisions for full-sensitivity setting.

5.4.3.10

Immediately after the preceding step, the stopwatch is started and simultaneously the leak isolation valve is closed as *rapidly as practical*. Alternatively, the recorder chart may be marked to indicate the beginning of the timed period and the leak isolation valve then closed rapidly.

5.4.3.11

The output is observed continuously and the stopwatch is stopped when the reading has decreased to 37% of the reading observed in Sec. 5.4.3.9. The reading of the stopwatch is noted (T sec.). Alternatively, the recorder

chart is examined to determine the time T required for the specific decrease in output. T is the response time (Sec. 3.9.2).

Note: *Should response time be a function of sensitivity setting, T as observed should be corrected to response time at full sensitivity setting, if any other setting was used.*

5.4.3.12

One minute after closing the leak valve (see Sec. 5.4.3.10), the output is read and noted. Correct for sensitivity setting as in 5.4.3.9.

5.4.3.13

The uncorrected signal due to the calibrated leak shall be taken as the difference between the reading noted in 5.4.3.9, and that noted in 5.4.3.12, the required conversion of these readings to equivalent scale divisions at full- sensitivity setting having been made.

5.4.3.14

The corrected signal due to the calibrated leak is taken as the difference between the uncorrected signal, Sec. 5.4.3.13, and the spurious signal correction in 5.4.2.11. The sensitivity is calculated by the formula below and should always be stated together with the response time, T:

$$\frac{\text{Sensitivity, with Response Time T} = \text{Signal due to Calibrated Leak}}{\text{Standard or Equivalent Standard Air Leak Rate of Calibrated Leak}}$$

The units are scale divisions (on full sensitivity setting) per unit leak rate (Sec. 3.5 and 3.8).

5.5. Minimum Detectable Leak

Referring to Sec. 5.3 and 5.4.3.14, this is calculated from the formula:

$$\frac{\text{Minimum Detectable Leak, with Response Time T} = \text{Minimum Detectable Signal}}{\text{Sensitivity}}$$

The units are those of leak rate.

From AVS Standard 2.3:

3.11 Peak Width, W

In a graphical spectrum, the length of the base of the peak, the base being defined by the intersection of the tangency of the legs of the peak with a reference base line. The specification of such a reference line is an important function of this standard. In some discussions, the symbol 3m or 3M is used for peak width rather than W . The units of W are atomic mass units; in some cases, a conversion of units may be necessary.

Section 3.16: Resolution

3.16.1 General Definition.

The ability, or a measure of the ability, of a mass spectrometer to separate the peaks produced by ions of different mass/charge ratios.

3.16.2 Absolute Resolution

(See General Definition above).

A measure of the ion-separating ability of a mass spectrometer, at a given mass M , given by the peak width, W , at M :

Absolute resolution (at M) = W amu

3.16.3 Unity Resolution Mass(es)

The mass number(s) at which the absolute resolution is one (amu) or “unity.”

3.16.4 Resolving Power

At a given mass M , the ratio of M to peak width W :

$$\text{Resolving Power} = \frac{M}{W} = \frac{M}{{}^3M} \quad (\text{See 3.11})$$

The charts in this section briefly summarize each of the major MS-50 controls and functions for easy reference, including:

- **Test (Norm) Mode: CRT Display Features**
- **Service Mode: CRT Display Features**
- **The Help Settings/System Menus**
- **The Service/Control Panel**
- **MS50 Automatic Leak Test Sequence**

Normal (Test) Mode: CRT Display

Leak Testing

Indicates test cycle has been initiated. When test cycle is complete, unit returns to **Ready To Test** status.

Reject Point

Displays user-selected maximum acceptable leak rate. Only displayed if Reject feature is set to **on**.

Test Port

Bar graph displays pressure at test port. May be scaled for mBar, mTorr, or Pascal. Display of test port graph may be toggled on or off via the Help/Settings menu. Purple caret indicates Reverse Crossover setpoint. Yellow caret indicates Direct Crossover setpoint.

Leak Rate

Bar graph indicates mantissa of leak rate of the measured object. Leak rate range display (at top right of bar graph) indicates leak range currently being tested. Number displayed above bar graph is a digital indicator of the leak rate mantissa.

Leak Rate Reject/Accept

Indicates whether detected leak falls above or below a pre-selected maximum acceptable range. Reject/Accept display may be toggled on or off via the

Auto/Manual

Below leak range display exponent; Auto or Manual is indicated according to ranging mode selected.

Change Crossovers

Press softkey [4] to adjust Reverse or Direct flow mode crossover setpoints.

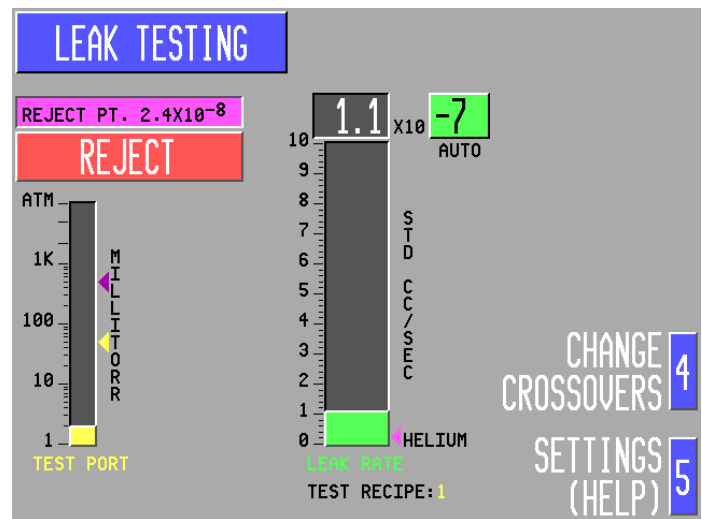
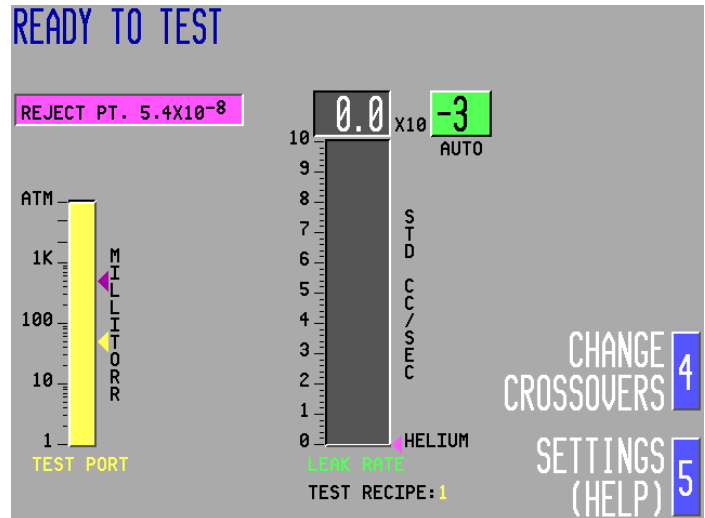

Settings (Help)

Press softkey [5] to display Help/Settings menu. Various system parameters may be set/alterd via this menu.

Test Recipe [#]

Indicates test recipe (1-50) currently selected. Test recipe may be changed through the Help/Settings menu

Service Mode

Activating Service Mode:

Turning Key-switch to right (Service Position) Places unit in service mode.

Current status of various vacuum system, mass spectrometer, and other system parameters will be monitored and displayed on CRT screen at right.

Service Mode on screen indicators are explained below:

Leak Rate

Leak Rate

Displays current leak rate in std cc/sec, Pascal M3/sec, or millibar liters/sec.

If system is set to detect He3, He3 will be displayed below leak rate.

If system is set for direct helium units, HELIUM will be displayed below the leak rate.

- If system is set for He4 or Air Equiv. no legend appears.

Amplifier Gains (G1-G4)

G1: Gross mode gain; set by user via Amp Gain up/down keys

G2: Reverse mode gain; set by computer during Tune/Calibration sequence

G3: Direct mode gain; set by computer during Tune/Calibration sequence

G4: Sniff mode gain; set by user via Amp

Fil. Amps

Displays filament supply current in DC amps; Maximum: 6.0 amps

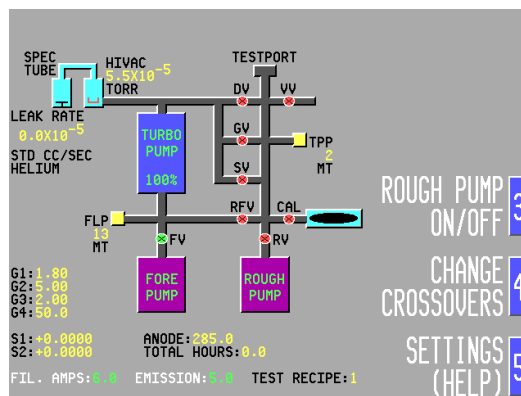

Anode

Anode Voltage, Displays accelerating voltage of mass spectrometer in DC volts.

Emission

Displays filament emission current in DC mA. Properly operating filament has emission of 5mA.

HiVac

Displays high vacuum pressure in Torr/mBar/Pascal. If filament is off, displays OFF

Turbo Pump

Percentage indicates relative operating speed of pump. When pump is turned on, “Turbo Pump” legend appears green.

Fore Pump

Indicates pump status; when pump is turned on, “Fore Pump” legend appears green.

Rough Pump

Indicates pump status; when pump is turned on, “Rough Pump” legend appears green.

FLP

Foreline Pirani. Foreline pressure indicated in milli Torr [MT], milliBar [MB], or Pascal [PA].

Service Mode (Continued)

TPP

Testport Pirani. Testport pressure indicated in milliTorr [MT], milliBar [MB], or Pascal [PA]

Valve Status

If valve symbol is green, valve is open.
If valve symbol is red, valve is shut.

Valves are labeled as follows:

DV	Direct valve
VV	Vent valve
GV	Gross valve
SV	Sniff valve
RFV	Reverse flow valve
FV	Foreline valve
RV	Rough valve
CAL	Calibrator valve

Rough Pump On/Off

Press softkey [3] to toggle Rough pump on or off.

Change Crossovers

Press softkey [4] to change Direct or Reverse flow mode crossover pressure setpoints.

Settings (Help)

Press softkey [5] to display Help/Settings Menu. Changes may be made to system parameters and stored.

Test Recipe

Displays number of currently selected Test Recipe.

Help Menus

HELP/SETTINGS:

Test Recipe

Select from up to 50 programmable test configurations.

Reject Point

Set maximum acceptable test object leak rate.

Reverse Crossover

Set pressure (10,000 mTorr max.) at which unit switches to Reverse flow mode.

Direct Crossover

Set pressure (200 Torr max.) at which unit switches to Direct flow mode.

Min. Rough Time

Set minimum rough pumping duration.

Min Gross Time

Set minimum Gross mode leak testing duration.

Reverse Rough Close

Specify delay (in seconds) between opening of Reverse valve and closing of Rough valve prior to Reverse flow mode testing.

Dir. Rough Close

Specify delay (in seconds) between opening of Direct valve and closing of Rough valve prior to

Dir. XOver Delay

Specify delay (in seconds) before opening Direct valve after Direct crossover pressure has been attained.

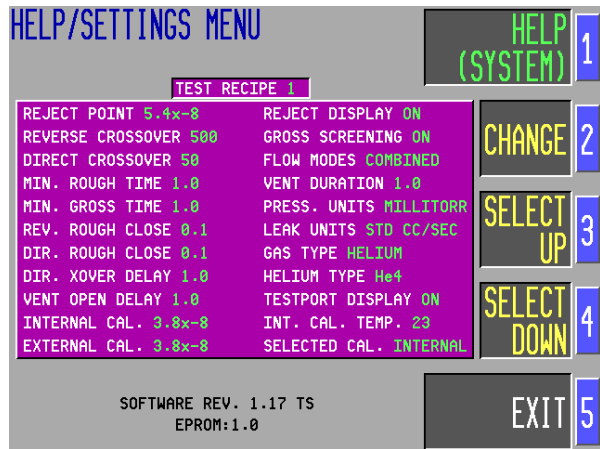

Vent Open Delay

Specify an amount of time (in seconds) VENT switch must be held down before actual venting of test port.

Internal Cal

Enter internal calibrator value (stamped on internal calibrator)

Help Menus (Continued)

External Cal

Enter external calibrator value (stamped on external calibrator)

Reject Display

Toggle leak test Reject/Accept display on or off.

Gross Screening

Enable or Disable Gross Screening option.

Flow Modes

Lock unit into Reverse or Direct flow mode, or set unit to combined (Reverse and Direct) flow mode switching.

Vent Duration

Set duration (in seconds) for Vent valve to remain open after test port pressure has been reached 760 Torr.

Pressure Units

Select unit of pressure (mTorr, mBar, Pascal) for onscreen displays.

Leak Units

Select unit of measurement (std cc/sec, mBar l/sec, Pascal M3./sec) to be used for onscreen displays.

Gas Type

Select Air Equivalent or Direct Reading (He)

Helium Type

Set system to detect He3 or He4.

Testport Display

Toggle test port pressure bar graph display on or off.

Internal Calibrator Temperature

Program temperature value at which internal leak rate standard was calibrated (stamped on internal calibrator).

Selected Cal.

Select Internal or External Calibrator for Cal Check and Tune functions.

HELP/SYSTEM:

Help

Display onscreen Help utility menus.

Time/Date









Change system Time of Day (in 24 hour format) and Calendar Date settings.

Language

Select English, French, or German language text display.

MS-50 User Panel Keys

Service Mode Keys

Function:	Key:	Active Modes:
<p>Cal Press to open or close Calibrator (internal temperature-compensated leak standard) valve.</p>		<p>Service</p>
<p>Direct Press to open or close Direct valve.</p>		<p>Service</p>
<p>Fore Press to open or close Foreline valve.</p>		<p>Service</p>
<p>Gross Press to open or close Gross valve.</p>		<p>Service</p>
<p>Reverse Press to open or close Reverse valve.</p>		<p>Service</p>
<p>Rough Press to open or close Rough valve.</p>		<p>Service</p>
<p>Sniff Press to open or close Sniff valve.</p>		<p>Service</p>
<p>Vent Press to open or close Vent valve.</p>		<p>Service</p>
<p>Aux 1 - Aux 4 Not used on standard MS-50 units</p>		<p>Service</p>

MS-50 User Panel Keys

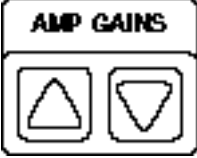
Function:	Key:	Active Modes:
<p>Amp Gains Press to adjust gain settings for gains G1 - G4 (gains are displayed on the Service mode CRT display screen - see Service Mode)</p>		<p>G2 & G3 – Service G3 & G4 – Set & Service</p>

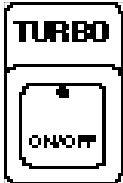
<p>Turbo Turns power to the Turbo pump on or off.</p>		<p>Service</p>
--	---	----------------

Control Keys

SYSTEM:

<p>Cal Check Performs an automatic calibration check using internal temperature-compensated leak standard.</p>		<p>Normal Set</p>
---	--	-------------------

<p>Tune Initiates fully automatic system tuning sequence when pressed.</p>		<p>Normal Set</p>
---	--	-------------------

MASS SPEC:

<p>Fil On/Off Toggles mass spectrometer filament on or off Can only be turned on if hi-vac pressure is sufficient; filament may not be turned off during leak testing. No protection in Service Mode</p>		<p>Normal Set Service</p>
---	--	-------------------------------

<p>Fil ½ Select Filament 1 or Filament 2; Green LED indicates good filament; Red LED indicates bad filament.</p>		<p>Normal Set Service</p>
---	--	-------------------------------

MS-50 User Panel Keys

Function: _____ **Key:** _____ **Active Modes:** _____

MODES:

Sleep

Places MS50 into Sleep mode prior to extended unit down time (ie, overnight, weekend). Evacuates test port, turns off rough pump and filament.



Normal Set

Vac/Sniff

Press to toggle between Vacuum and Sniff leak testing modes.

Normal Set

ZERO/Set:

When pressed, “cancels out” any leak rate currently being measured; allows zeroing of test object background. Limits ranging to two decades below “zeroed” range. Only active during leak testing.



Normal Set

SCAN Keys:

Pressing up/down arrow keys will momentarily offset mass spectrometer accelerating voltage +/- 30 volts and cause the displayed leak rate to decrease to zero in an optimally tuned unit. Provides positive identification of helium during a leak test. In Service mode, changes mass spectrometer peak voltage in 1 volt increments

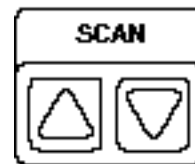

Normal Set Service

AUDIO Keys:

Press Mute to turn off speaker/headphone used for audio monitoring of leak testing. Up/down arrow keys adjust audio volume. If Reject Display is “On”, audio is activated only if leak rate exceeds user-programmed Reject point.



Normal Set Service

RANGING Keys:

Press Auto/Manual key to set MS50 to automatic or manual Ranging mode. Use arrow keys to range up (toward 100) or range down (toward 10⁻¹⁰). In Service mode, Auto/Manual key is not used.

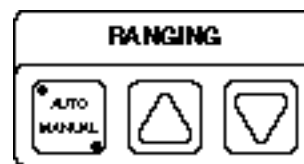

Normal Set Service

MS-50 User Panel Keys

Function: _____ **Key:** _____ **Active Modes:** _____

SOFTKEYS [1-5]:

Softkeys correspond to numbers displayed beside onscreen menu options. The user presses the appropriate softkey to select or alter system settings and navigate the onscreen menus.



**Normal Set
Service**

Start/Vent Panel

START Switch (Green):
Initiates a pump/test sequence. Pressing a second time interrupts the test cycle without venting unit. Switch lights when test cycle has been started.



Normal Set

VENT Switch:
Press momentarily to halt test cycle; Press and hold (for a preset duration) to halt test cycle and vent test port to atmosphere.

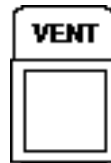

Normal Set

MS-50 Automatic Leak Test Sequence

Starting Up The MS-50:

1. Turn on Power I/O switch (located on unit's front panel) or [1] Power Up if unit is in Sleep Mode (see step 15).

2. CRT displays "Loading System Program - Please Wait"

3. CRT displays Power Up in Progress; foreline valve opens; turbo pump accelerates and begins pumping down high vacuum system; Foreline and High Vac bar graph indicators show vacuum system pressure dropping

4. When turbo pump reaches full speed, mass spectrometer Filament is turned on (indicated by green LED on Fil On/Off key).

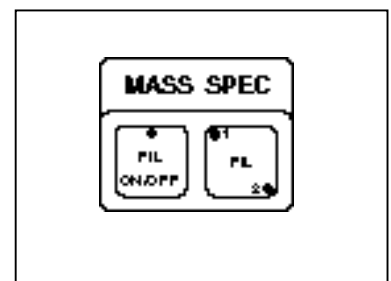
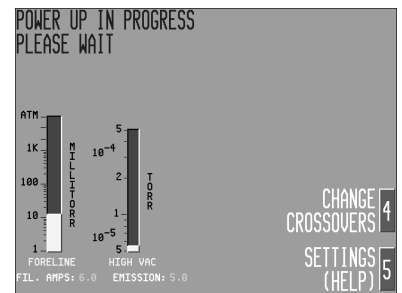
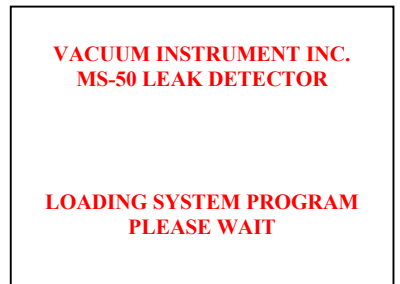
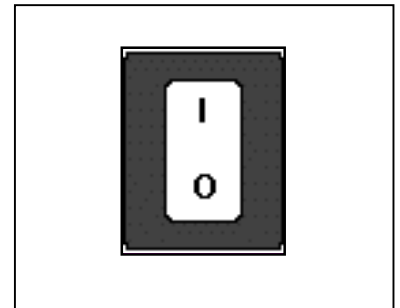

Ready to Test:

5. System background and offsets are measured. When high vacuum system pressure drops below 5×10^{-4} MS-50 is ready for use.

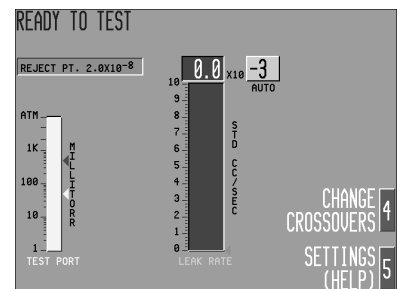

MS-50 Automatic Leak Test Sequence

Cal Check/Tune:

- 6. Automatically subtracts background, optimizes mass spectrometer voltages and system gains, and calibrates unit to internal leak rate standard. Twice daily Cal Check is recommended; Tune as needed following Cal Check (at least once per week is recommended)

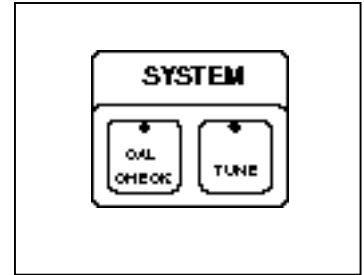

Select Test Recipe:

- 7. Press [5] Settings/Help in Ready to Test screen to display test recipes. Press [3] Select Up and [4] Select Down to change recipe number. Press [5] Leave Menu to return to Ready to

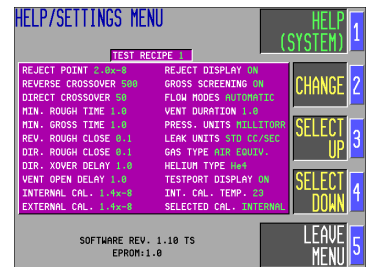

Vent Test Port:

- 8. Press to bring test port pressure to atmosphere, allowing test object to be attached.

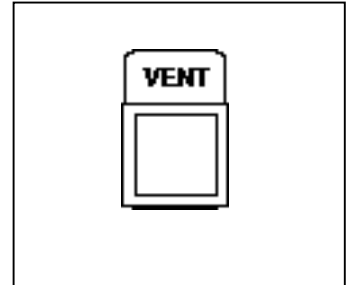

Attach Test Object:

- 9. Remove blank covering test port and attach test object to the test port.



Press START Button:

- 10. MS-50 begins test object pump down.

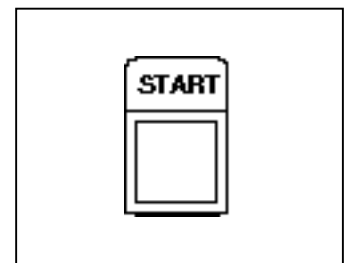

MS-50 Automatic Leak Test Sequence

Leak Testing:

- 11. Spraying of test object with helium should now commence.

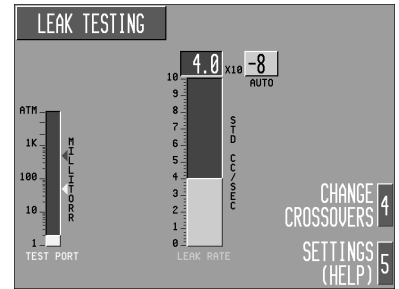

Leak Testing - Reject:

- 12. Displayed if leak rate meets or exceeds user-set Reject setpoint (default is 2.0 x 10⁻⁸)

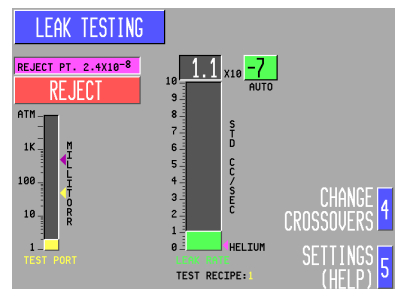

Leak Testing - Accept:

- 13. Displayed if leak rate falls below user-specified Reject setpoint

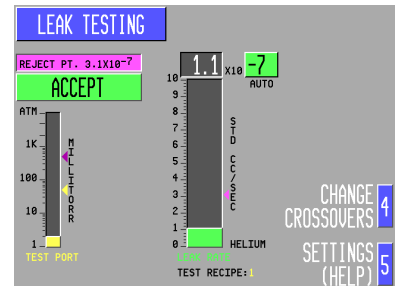

Vent Test Port & Remove Test Object:

- 14. When finished testing, press and hold VENT button to vent test port to atmospheric pressure. Remove test object and replace test port blank.

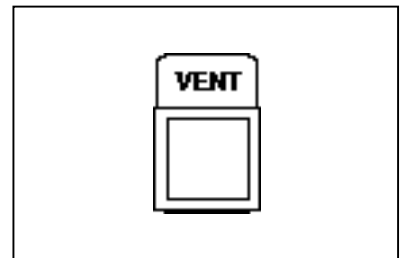

Sleep Mode/Power Down:

- 15. Powers down unit while maintaining high-vacuum state. Computer pumps down test port; unit crosses over to Direct mode; filament and Rough pump turned off; CRT screensaver activated. Sleep mode is deactivated when [1] Power Up key is pressed.

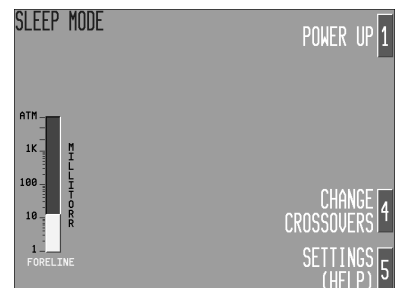

**WARNING:**

This information should only be used by experienced and knowledgeable personnel.

Full PC Remote Control Specification

Using the following specification, software can be written to enable a remote computer to completely control the MS-50 Leak Detector. The remote computer can control every function of the leak detector except for service functions. Service Mode cannot be entered by the remote computer.

Pressures, valve status, current state, and other operating parameters can all be monitored over this communications link. All data is transmitted serially and each byte consists of one ASCII character. Each packet of information begins with an ASCII character between the letter “A” and the letter “I”. All packets contain a fixed number of bytes. The description of each packet will clarify this point. Every packet, minus its initial letter, is made up of the ASCII numbers “0” through “9”. The beginning of each packet dictates the end of the previous packet unless terminated with a carriage return or a line feed.

“A” - Followed by a “1”.

“1” - indicates an invalid command was sent by the remote PC. It could mean that the format of the command was incorrect, or an attempt was made to change a parameter to an invalid value.

“B” - Not used in the MS-50 at this time.

“C” - Followed by 5 numbers.

Leak Rate Value measured in atm-cc/sec or mbar-l/sec.

(e.g. 05708 ⇔ 5.7×10^{-8} atm-cc/sec)

(e.g. 10010 ⇔ 10.0×10^{-10} atm-cc/sec)

“D” - Followed by 6 numbers.

Foreline Pressure measured in Millitorr (from 0 to 760000 millitorr).

(e.g. 000100 ⇔ 100 millitorr) (e.g. 760000 ⇔ 760000 millitorr)

“E” - Followed by 6 numbers.

Testport Pressure measured in Millitorr (from 0 to 760000 Millitorr).
(e.g. 000100 ⇔ 100 millitorr)
(e.g. 760000 ⇔ 760000 millitorr)

“F” - Followed by 3 numbers.

High Vacuum Pressure measured in Torr (from 7.5×10^{-4} to 2.6×10^{-5}).
(e.g. 105 ⇔ 1.0×10^{-5} Torr)
(e.g. 384 ⇔ 3.8×10^{-4} Torr)

“G” - Followed by 3 numbers.

Filament Current measured in amperes.
(e.g. 023 ⇔ 2.3 Amps.)
(e.g. 185 ⇔ 18.5 Amps.)

“H” - Followed by 7 numbers.

Emission Current (3 numbers) measured in milliamps.
Reject Status (“0”, or “1” ⇔ Invalid, “2” ⇔ Accept, “3” ⇔ Reject)
Ready Light (“0” ⇔ OFF, “1” ⇔ ON)
Testing Light (“0” ⇔ OFF, “1” ⇔ ON)
Start Light (“0” ⇔ OFF, “1” ⇔ ON)
(e.g. 0230100 ⇔ 2.3 milliamps, Invalid, Ready ON, Testing OFF, Start OFF)
(e.g. 0553011 ⇔ 5.5 milliamps, REJECT, Ready OFF, Testing ON, StartON)

“I” - Followed by 2 numbers.

Present State of the leak detector.
(e.g. 00 - First Power)
01 - Power Up
02 - Power Up
03 - Power Up
[States 4 - 10 are for Vacuum Mode, Auto-Ranging]
04 - Standby
05 - Standby
06 - Roughing Testport
07 - Gross Mode Leak Testing
08 - Reverse Rough Close Delay
09 - Reverse Mode Leak Testing
10 - Direct Rough Close Delay
11 - Direct Mode Fine Leak Testing

[States 12 - 19 are for Vacuum Mode, Manual-Ranging]

- 12 - Standby
- 13 - Standby
- 14 - Roughing Testport
- 15 - Gross Mode Leak Testing
- 16 - Reverse Rough Close Delay
- 17 - Reverse Mode Leak Testing
- 18 - Direct Rough Close Delay
- 19 - Direct Mode Leak Testing

[States 20 - 23 are for Sniffer Mode, Auto-Ranging]

- 20 - Standby
- 21 - Standby
- 22 - Roughing Sniffer Probe
- 23 - Sniffer Mode Leak Testing

[States 24 - 27 are for Sniffer Mode, Manual-Ranging]

- 24 - Standby
- 25 - Standby
- 26 - Roughing Sniffer Probe
- 27 - Sniffer Mode Leak Testing

- 28 ⇔ 40 - Automatic Tuning
- 41 ⇔ 47 - Checking Calibration
- 48 ⇔ 51 - Sleep Mode
- 52 - Service Mode

“J” - Followed by 4 numbers.

Reject Set Point in atm-cc/sec.

(e.g. 2300 ⇔ 2.3×10^{-0} atm-cc/sec)

(e.g. 5708 ⇔ 5.7×10^{-8} atm-cc/sec)

“K” - Followed by 3 numbers.

Direct Flow Crossover #2 in millitorr.

(e.g. 010 ⇔ 10 millitorr)

(e.g. 100 ⇔ 100 millitorr)

“L” - Followed by 17 numbers.
System Status Information:

Char#

1	☞ Turbo Pump Status	(“0” = OFF, “1” = ON)
2	☞ Filament Status	(“0” = OFF, “1” = ON)
3	☞ Vent Valve Status	(“0” = CLOSED, “1” = OPEN)
4	☞ Sniff Valve Status	(“0” = CLOSED, “1” = OPEN)
5	☞ Gross Valve Status	(“0” = CLOSED, “1” = OPEN)
6	☞ Foreline Valve Status	(“0” = CLOSED, “1” = OPEN Dual Port Only)
7	☞ Direct Valve Status	(“0” = CLOSED, “1” = OPEN)
8	☞ Calibrator Valve Status	(“0” = CLOSED, “1” = OPEN Dual Port Only)
9	☞ Reverse Valve Status	(“0” = CLOSED, “1” = OPEN)
10	☞ Rough Valve Status	(“0” = CLOSED, “1” = OPEN)
11	☞ Aux 1 Valve Status	(“0” = CLOSED, “1” = OPEN)
12	☞ Aux 2 Valve Status	(“0” = CLOSED, “1” = OPEN)
13	☞ Aux 3 Valve Status	(“0” = CLOSED, “1” = OPEN)
14	☞ Aux 4 Valve Status	(“0” = CLOSED, “1” = OPEN)
15	☞ Zero Light Status	(“0” = OFF, “1” = ON)
16 & 17	☞ Error Status	

“01”	Foreline Pressure Too High
“02”	High Vacuum Pressure Too High
“04”	Auto Zero Error
“05”	Foreline Pressure Too High To Test
“07”	High Voltage Failure
“08”	Filament Current Too Low
“09”	Temperature Too High
“10”	Emission Current Too Low
“11”	PC Remote Communications Error
“13”	Rough Time Exceeded
“18”	Printer Error
“22”	Temperature Too Low
“23”	Cannot Find Helium Peak
“24”	Gain Too High
“26”	Turbo Pump Failure
“30”	Hand Held Remote Communications Error
“33”	Repeller Heat Failure
“51”	No Errors

(e.g. L11000111000000151 ⇨ Turbo Pump On, Filament On, Vent Valve Closed, Sniff Valve Closed, Gross Valve Closed, Foreline Valve Open, Direct Valve Open, Calibrator Valve Open, Reverse Valve Closed, Rough Valve Closed, Aux 1 Valve Closed, Aux 2 Valve Closed, Aux 3 Valve Closed, Aux 4 Valve Closed, Auto Zero Light On, No Errors)

“M” - Not used in the MS-50.

“N” - Followed by 3 numbers.

Current Calibrator Temperature in Degrees Celsius.

(e.g. 202 ⇨ 20.2°C)

“O” - Followed by 3 numbers.

Anode Voltage measured in Volts.

(e.g. 265 ⇨ 265.0 Volts)

(e.g. 310 ⇨ 310.0 Volts)

“P” - Followed by 2 numbers.

For Vacuum Instruments internal use only!

“Q” - Followed by 2 numbers.

For Vacuum Instrument internal use only!

“R” - Followed by 2 numbers.

For Vacuum Instrument internal use only!

“S” - Followed by 5 numbers.

Gross Flow Gain (G1).

(e.g. 0200 ⇨ 2.00 x gain)

(e.g. 1000 ⇨ 10.00 x gain)

“T” - Followed by 5 numbers.

Reverse Flow Gain (G2).

(e.g. 0200 ⇨ 2.00 x gain)

(e.g. 1000 ⇨ 10.00 x gain)

“U” - Followed by 5 numbers.

Direct Flow Gain (G3).

(e.g. 0200 ⇨ 2.00 x gain)

(e.g. 1000 ⇨ 10.00 x gain)

“V” - Followed by 4 numbers.

Crossover #1 or Reverse Flow Crossover in millitorr.

(e.g. 0010 ⇨ 10 millitorr)

(e.g. 0200 ⇨ 200 millitorr)

(e.g. 9000 ⇨ 9000 millitorr)

“W” - Followed by 4 numbers.

Stamped Leak Rate on Internal Calibrator in atm-cc/sec.

(e.g. 0000 ⇨ 0.0 x 10⁻⁰ atm-cc/sec)

(e.g. 2300 ⇨ 2.3 x 10⁻⁰ atm-cc/sec)

(e.g. 5708 ⇨ 5.7 x 10⁻⁸ atm-cc/sec)

“X” - Followed by 2 numbers.

Stamped Temperature on Internal Calibrator in Degrees Celsius.

(e.g. 20 ⇨ 20.0°C)

(e.g. 35 ⇨ 35.0°C)

“Y” - Followed by 4 numbers.

Direct Crossover Delay (D1) in Tenths of seconds.

(e.g. 0001 ⇨ 0.1 seconds)

(e.g. 0142 ⇨ 14.2 seconds)

“Z” - Followed by 4 numbers.

Direct Rough Close Delay (D2) in Tenths of seconds.

(e.g. 0072 ⇨ 7.2 seconds)

(e.g. 0217 ⇨ 21.7 seconds)

“[“ - Followed by 4 numbers.

Vent Valve Open Delay (D3) in Tenths of seconds.

(e.g. 0010 ⇨ 1.0 seconds)

(e.g. 0152 ⇨ 15.2 seconds)

“\” - Followed by 4 numbers.

Vent Valve Close Delay (D4) in Seconds.

(e.g. 0020 ⇔ 2.0 seconds)

(e.g. 0103 ⇔ 10.3 seconds)

“]” - Followed by 10 numbers.

**Filament #, Helium Mass, Gas Type, Pressure Units, Leak Rate Units,
FLASH Revision, and EPROM Revision**

Char#

1 ⇔ Filament ž status (“1” = Filament #1, “2” = Filament #2)

2 ⇔ Helium Mass (“3” = He3, “4” = He4)

3 ⇔ Gas Type (“0” = Air Equiv. Units, “1” = Helium Units)

4 ⇔ Pressure Units (“0” = mTorr, “1” = mBar, “2” = Pascal)

5 ⇔ Leak Rate Units (“0” = std cc/sec, “1” = mBar/l sec, “2” = Pa M3/Sec)

6,7 & 8 ⇔ FLASH Rev. (“102” ⇔ FLASH Rev. 1.02)

9 & 10 ⇔ EPROM Rev. (“15” ⇔ FLASH Rev. 1.5)

(e.g.]1400010114 ⇔ **Filament On, He4, Air Equiv. Units, mTorr, std cc/sec
FLASH 1.01, EPROM 1.4**)

“^” - Followed by 4 numbers.

For Vacuum Instrument internal use only!

“_” - Followed by 4 numbers.

For Vacuum Instrument internal use only!

“'” Followed by 3 numbers.

Turbo Pump Speed in percent of full speed.

(e.g. 015 ⇔ 15% of full speed)

(e.g. 075 ⇔ 75% of full speed)

“a” - Followed by 4 numbers.

Minimum Gross Testing Time (D5) in Tenths of seconds.

(e.g. 0001 ⇔ 0.1 seconds)

(e.g. 0142 ⇔ 14.2 seconds)

“b” - Followed by 6 numbers.**Total Running Time** in Hours.

(e.g. 000001 ⇨ 1 hour)

(e.g. 000032 ⇨ 32 hours)

“c” - Followed by 4 characters.**Minimum Roughing Time (D6)** in Tenths of Seconds.

(e.g. 0001 ⇨ 0.1 seconds)

(e.g. 0142 ⇨ 14.2 seconds)

“d” - Followed by 3 numbers.**Sniffer Gain (G4).**

(e.g. 020 ⇨ gain of 20)

(e.g. 100 ⇨ gain of 100)

“e” - Followed by 4 numbers.**Reverse Rough Close Delay (D7)** in Tenths of seconds.

(e.g. 0001 ⇨ 0.1 seconds)

(e.g. 0142 ⇨ 14.2 seconds)

The following options for serial stream transmission are available to the user:

1. The user can select individual packet(s) to be sent all the time or on demand. On power-up the MS-50 will default to all packets selected to be sent. However, no packets will be transmitted until the MS-50 is remotely commanded to do so.
2. The user can terminate each packet with either a carriage return or a line feed. The default will be no terminators. The terminator instruction will be “T0Z” for no termination. “T1Z” will enable the carriage return as the terminator. “T2Z” will enable the line feed as the terminator. Each command will override the previous.
3. The default packet set will be all packets. If a smaller number of packets is desired, then the array can either be cleared or a specific packet can be eliminated from the set. The clear instruction is “E0Z”. If the MS-50 receives this command, only the “A” packet will be sent. To reset the stream to all packets, the command “E1Z” should be sent. To stop a specific packet from being sent, the “Gab0Z” command can be sent to the MS-50 where “ab” is the packet number. (i.e. if “ab” = “02”, then the 2nd packet or “C” packet will never be sent.) To add a packet to the stream, the “Gab1Z” command must be sent (i.e. if “ab” = “17”, then the 17th packet or “R” packet will now be sent in the stream.)

NOTE:

The “00” or “A” packet will always be included in the stream. This will force all serial stream lengths to be the same.

4. To cause the stream to be sent using the original MS-40 format, send the “I1Z” instruction. “I0Z” will terminate the stream and revert back to the original format. Read note below.

5. “PxyZ” is the single packet query instruction. This will send only the “xy”th packet and no others. (If x=2 and y=3, the 23rd packet will be sent.) Issuing this instruction will cause the serial stream to stop after its last packet. If the user has 5 packets being sent, the array will not be cleared, but if they were being sent out continuously, this would stop. Once the stream stops, then the desired packet “xy” will follow and nothing more will be sent.

6. “Q1Z” is the multiple packet query instruction. This will only send the packet(s) in the array once. If packets “C”, “D”, and “G” are in the array, then all three packets will be sent and nothing more. If the packets were being sent out continuously, the serial stream will stop with this last burst of packets.

7. “S1Z” will cause packet(s) to be sent continuously. “S0Z” will halt packet transmission.

NOTE:

To maintain compatibility with software written for MS-40 Portable Leak Detectors, we have included the ability to have the serial stream transmitted using the old MS-40 format. This can be achieved by sending the “I” command as mentioned in #4 from above. Under this format, packets “C” through “I” are sent all the time. Packets “A” and “B” are only sent when necessary. Packets “L” and “N” are sent every third time after packet “I”. Packets “J”, “K”, and “O” through “I” are sent every 33 times after packets “L” and “N”.

NOTE:

The packets are transmitted in the following order:

Packet #	Packet Letter	Packet #	Packet Letter
00	A	20	V
01	B	21	W
02	C	22	X
03	D	23	Y
04	E	24	Z
05	F	25	[
06	G	26	\
07	H	27]
08	I	28	^
09	L	29	(underscore)
10	N	30	(left single quote)
11	J	31	a
12	K	32	b
13	O	33	c
14	P	34	d
15	Q	35	e
16	R	36	f
17	S	37	g
18	T	38	h
19	U	39	i

The remote computer has to issue the “S” command to the MS-50 before it will transmit any data. This command is made up of 3 ASCII characters. “S1Z” will command the MS-50 to start transmitting data. “S0Z” will command the MS-50 to stop transmitting data. This method is **not** to be used for RS-232 hand-shaking.

The remote PC or controller has the ability to send many different commands to the MS-50. There are two basic types of commands. One command is equivalent to pressing a key on the MS-50’s user panel and the other type is equivalent to a parameter change. The key press commands allow for remote control and the parameter changing commands allow the remote computer or controller to change either the system delay, testing crossover pressures, or change the **REJECT** setpoint.

Most remote commands will be sent to control normal operation/cycling of the MS-50 leak detector. Normal starting and stopping of test cycles will be controlled remotely. If the remote computer is making leak test decisions, such as how long to test a specific part, the software must be aware that accurate leak rates only occur in the **GROSS, REVERSE, DIRECT** and **SNIFFER** testing states. Roughing states do not test for the presence of helium and rough close delay states corrupt the flow of helium





























by pumping some of the helium away with the rough pump. Leak test decisions should not be made in these states. Also, during normal test cycles, if the high vacuum pressure exceeds 5.0×10^{-4} Torr, the filament is turned **OFF** but the leak test cycle is not terminated. This is called the **PRESSURE BURST CLEANUP** mode. The filament on/off flag sent with the “L” packet is one method of monitoring this state. However, if using the old compatible serial stream format, monitoring the filament current will give the remote computer a faster response to this situation. Filament on/off status is sent on every third transmission of the filament current as mentioned above. The filament will be turned back on every 10 seconds to check the high vacuum pressure. If the pressure is still too high, the filament will shut itself back off, otherwise it will remain on and testing will continue.

If the remote computer or controller wants to terminate a test cycle based upon a certain length of time in testing mode, the time spent in **PRESSURE BURST CLEANUP** should not be included in this time. Testing parts for helium does not occur at these times. Also, if the remote computer terminates the test because of an **ACCEPT** or **REJECT** indication, do not terminate the test cycle when the reject status is **INVALID**. This will not harm the MS-50, but will not give a positive **ACCEPT** or **REJECT** signal.

Below is a list of all possible remote PC commands that may be sent to the MS-50 and do not control the format of the serial stream. All commands begin with one of these letters [“D”, “F”, “K”, “M”, “R”] and are all terminated by the letter “Z”. The numbers in the middle make up the desired command. All key press commands start with the letter “K” and end with the letter “Z”. Each key press command works in exactly the same fashion as if an operator had pressed the corresponding key on the leak detector. There are 29 different key-press commands, each requiring 2 numbers, and they are the following:

Command #

- 00 ⌨ Start Button (Right Start Button on MS-50 Dual Port)
- 01 ⌨ Vent/Standby Button
- 02 ⌨ Start Left Button (Used only on MS-50 Dual Port)
- 03 ⌨ Softkey #1
- 04 ⌨ Softkey #2
- 05 ⌨ Softkey #3
- 06 ⌨ Softkey #4
- 07 ⌨ Softkey #5
- 08 ⌨ Calibrator Valve Button
- 09 ⌨ Direct Valve Button
- 10 ⌨ Gross Valve Button

- 11  Reverse Valve Button
- 12  Rough Valve Button
- 13  Sniffer Valve Button
- 14  Vent Valve Button
- 15  Foreline Valve Button
- 16  Aux 1 Valve Button (Left Port Valve on MS-50 Dual Port)
- 17  Aux 2 Valve Button (Right Port Valve on MS-50 Dual Port)
- 18  Aux 3 Valve Button (Left Vent Valve on MS-50 Dual Port)
- 19  Aux 4 Valve Button (Right Vent Valve on MS-50 Dual Port)
- 20  Amp Gain Up
- 21  Amp Gain Down
- 22  Turbo Pump Button
- 23  Cal-Check Button
- 24  Tune Button
- 25  Filament ON/OFF button
- 26  Filament 1/2 Button
- 27  Sleep Mode Button
- 28  Vac/Sniff Mode Button
- 29  Zero Button
- 30  Scan Up Button
- 31  Scan Down Button
- 32  Mute Button
- 33  Volume Up Button
- 34  Volume Down Button
- 35  Auto/Manual Ranging Button
- 36  Range Up Button
- 37  Range Down Button
- 38  System Vent Command (Can only be sent in **STANDBY** states)

To send a command to Auto-Zero a leak, the remote PC or controller must send the following command string:
“K29Z”

To send a command to Start a leak test cycle, the following string must be sent to the MS-50: “K00Z”

To set one of the seven system delays, the PC must send a command that starts with a “D”, followed by 5 numbers, and ends with a “Z”. The first number is the delay number [1, 2, 3, 4, 5, 6, 7] and the last 4 numbers make up the desired delay in tenths of a second.

For a direct crossover delay (Delay #1) of 2.0 seconds, the following string must be sent: “D10020Z”

For a direct rough close delay (Delay #2) of 0.1 seconds, the following string must be sent: “D20001Z”

For a vent open delay (Delay #3) of 5.0 seconds, the following string must be sent: “D30050Z”

For a vent close delay (Delay #4) of 12.5 seconds, the following string must be sent: “D40125Z”

For a minimum Gross Leak Test time (Delay #5) of 7.0 seconds, the following string must be sent: “D50070Z”

For a minimum roughing time (Delay #6) of 20.0 seconds, the following string must be sent: “D60200Z”

For a reverse rough close delay (Delay #7) of 0.1 seconds, the following string must be sent: “D70001Z”

If an attempt is made to change a delay to an invalid value, the MS-50 will clip the value to either its upper or lower limits and will send back an error indication in its stream of data (“A1”). If it is clipped, its new value will show up in the appropriate portion of the data stream.

To set one of the crossovers, either #1 or #2, the PC must send a command that starts with an “F”, followed by 5 numbers, and ends with a “Z”. The first number is the crossover number (“1” for crossover #1 and “2” for crossover #2). The next 4 numbers make up the desired crossover pressure in millitorr.

For a Reverse crossover (#1) of 350 millitorr, the following string must be sent: “F10350Z”

For a Direct crossover (#2) of 25 millitorr, the following string must be sent:
“F20025Z”

If an attempt is made to change a crossover to an invalid value, the MS-50 will clip the value to either its upper or lower limits and will send back an error indication in its stream of data (“A1”). If it is clipped, its new value will show up in the appropriate portion of the data stream.

The **REJECT** setpoint change command starts with an “R”, has 4 numbers, and is ended with a “Z”. The first 2 numbers make up the reject mantissa and the last 2 make up the reject exponent. Here the exponent is assumed to be negative.

For a reject point of 2.0×10^{-8} , the following string must be sent to the MS-50:
“R2008Z”

For a reject point of 5.0×10^{-10} , the following string must be sent:
“R5010Z”

For a reject point of 6.3×10^{-7} , the following string must be sent:
“R6307Z”

If an attempt is made to change the **REJECT** setpoint to an invalid value, the MS-50 will clip the value to either its upper or lower limits and will send back an error indication in its stream of data (“A1”). If it is clipped, its new value will show up in the appropriate portion of the data stream.

As an example, let’s go through the sequence of a remotely controlled leak test cycle. First we monitor the present state packet “I”. We wait for the MS-50 to power-up and go into the standby states 4, 5, 12, or 13. At this time we can check the crossover points, the delays, and the **REJECT** setpoint to make sure they are appropriate for the part being tested. If they are not correct, we can change them using the appropriate commands. We will set the Reverse crossover pressure to 200 millitorr by sending the string of “F10200Z” because this is crossover #1. We will set the **REJECT** setpoint to 2.0×10^{-8} atm-cc/sec by sending the string of “R2008Z”. After we send each of the following strings, we must monitor the MS-50 data stream to verify that both an error (“A1”) has not occurred and that the crossover and reject values have been updated.

Once this has been completed, we can now start the test cycle. To start the test cycle we must send the string of “K00Z”. At this time we monitor the data stream to make sure an error (“A1”) was not generated and that the leak detector has changed to the **ROUGHING TESTPORT** state 6 or 14. After this

happens, we still monitor the present state and the reject status. Once the reject status changes to either an **ACCEPT** or a **REJECT**, we can terminate the test cycle by sending the string “K01Z”. At this time the present state will change to 4, 5, 12, or 13 and we will need to vent the test port to enable the operator to remove the test object. For this we need to send the string “K15Z”.

Now the sequence can be repeated for more test objects.

If we want to **SNIFF** test, the sequence wouldn't change except for the present state values. First we would have to change the present state from a Vacuum Mode standby to a Sniffer Mode standby by sending the string “K13Z” when the MS-50 was in one of the vacuum mode standby states of 4, 5, 12, or 13. This will cause the MS-50 to change to either state 20, 21, 24, or 25. If the leak detector is set for manual ranging, the Sniffer Mode standby states would be 24 or 25. Once the correct standby state has been entered, we can continue with the normal operational sequence.

During a test cycle, if we wanted to change from manual ranging to automatic ranging or vice-versa, all we have to do is send the string “K23Z” which is equivalent to pressing the Auto/Manual Ranging Button on the MS-50 s user panel.

The RS-232 data format is:

- a. 8 Data Bits
- b. Even Parity
- c. 9600 Baud
- d. 1 Stop Bit

Hand-shaking is done by using a **NULL MODEM** adapter or equivalent and observing the following rules:

1. The MS-50 will start sending the data stream when it is issued the appropriate command (“S1Z”).
2. The MS-50 will not transmit when its CTS line (RTS line of remote PC) is driven low. This should only be done during serial port interrupts on the remote PC.
3. The remote PC must not send data to the MS-50 when the MS-50 has driven its RTS line low (CTS line of PC remote).

Point To Point Wiring for MS-50 and remote Computer

NOTE:

A standard **NULL MODEM** cable will work or a straight through RS-232 cable with a **NULL MODEM** adapter can be used.

The MS-50 9-pin Connector is designated RS232 on the rear of the leak detector.

MS-50 9-pin Connector		Computer 25-Pin Connector
1, 6		20
2		2
3		3
4		6, 8
5		7
7		5
8		4
9		Not Connected 22

MS-50 9-pin Connector		Computer 9-Pin Connector
1, 6		4
2		3
3		2
4		6, 1
5		5
7		8
8		7
9		Not Connected 9

Introduction

The MS-50 Dual Port configuration provides two separate test ports for leak testing. This allows users with a particularly long set-up time to attach a test apparatus or load a fixture in one port while leak testing is occurring on the other port.

Each port has a dedicated Port Valve, which connects the port to the main vacuum system, and a Vent Valve, which opens the port area to atmosphere. The two ports are isolated from each other during normal operation. The vacuum system schematic for the MS-50 Dual is illustrated in the Service Mode screen below.

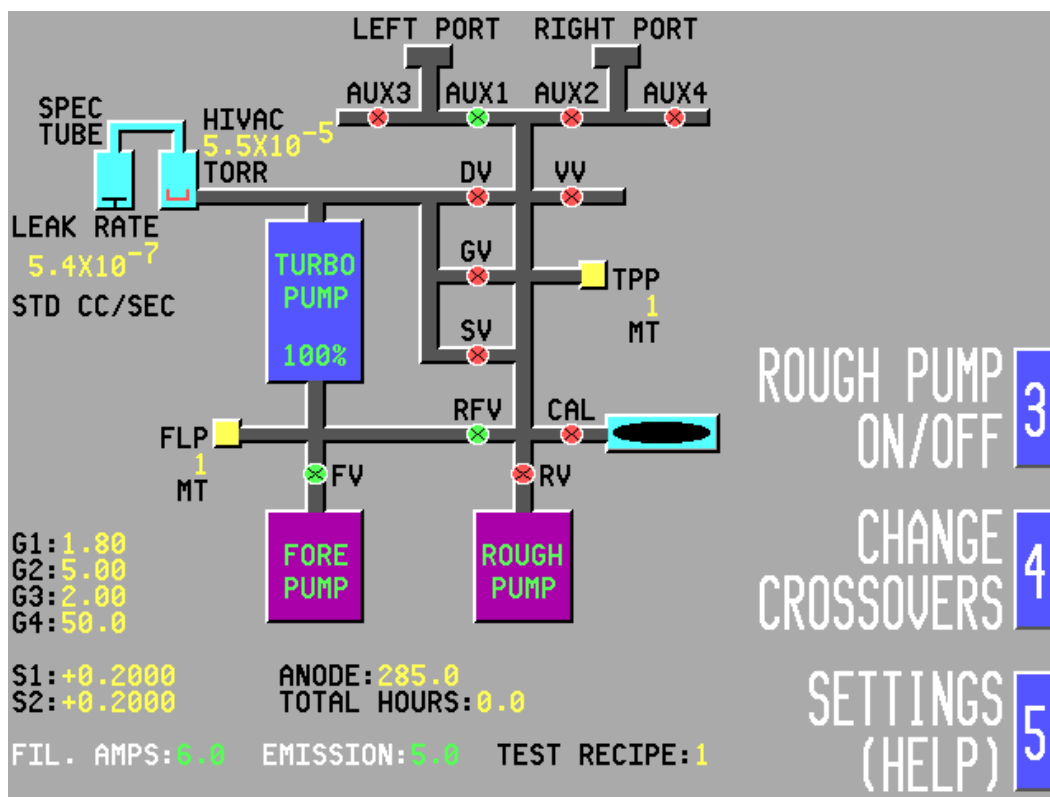
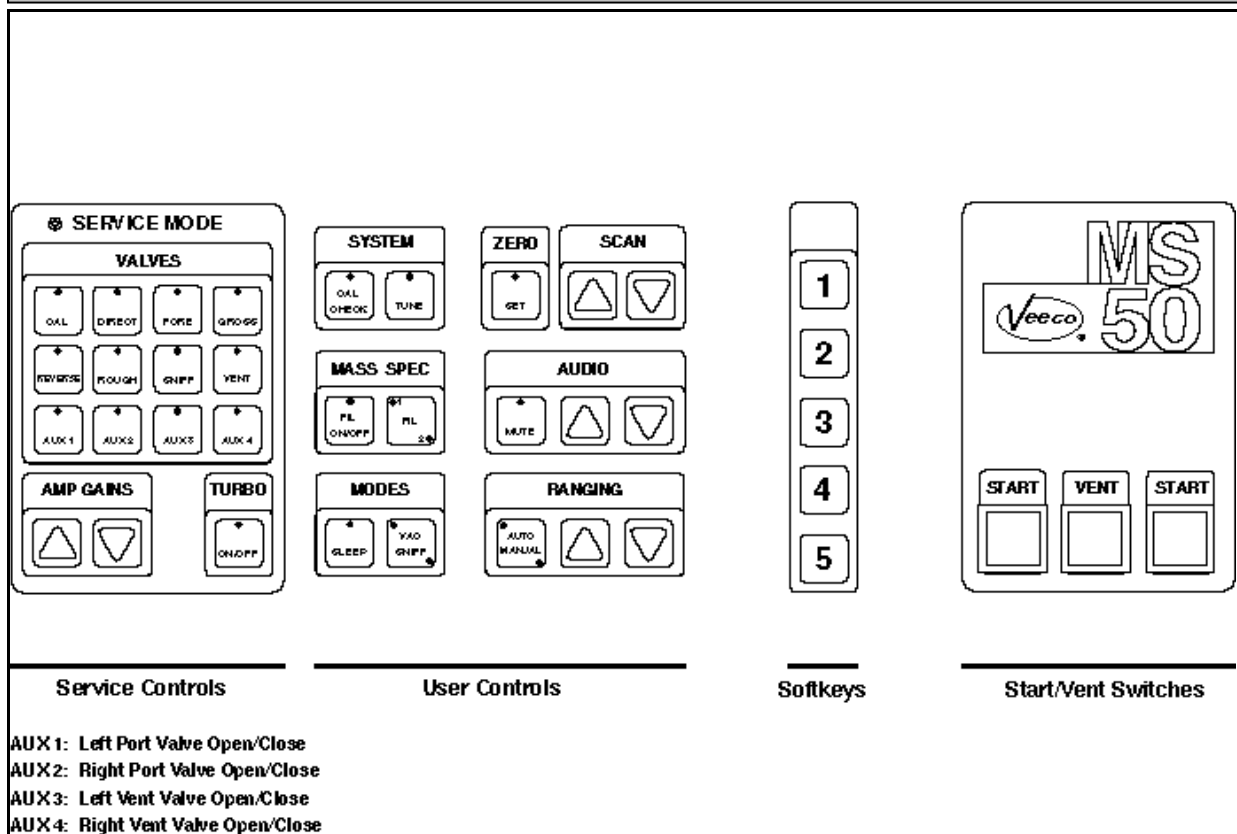

Figure G-1 Dual Port Vacuum System Schematic

Figure G-2 Dual Port User Panel



General Operation

Operation of the MS-50 Dual and the standard MS-50 is in most respects identical. In MS-50 Dual units, two test ports are being controlled instead of one; consequently, there are two green START switches on the User Panel, one for the left port and one for the right port (see fig. G-2). A single red VENT switch controls both port vent valves (as well as the main vacuum system vent valve).

Pressing either the left or right START switch initiates a test cycle in the corresponding test port. The port valve (fig. G-1, AUX1 or AUX2) opens, followed by the rough valve (fig. G-1, RV). The system then pumps down the test port. During this time, the operator may remove test objects from the opposite port, even if the port was not vented after the previous test cycle. This is because the test port opposite from the one under test is vented automatically when a new test is started.

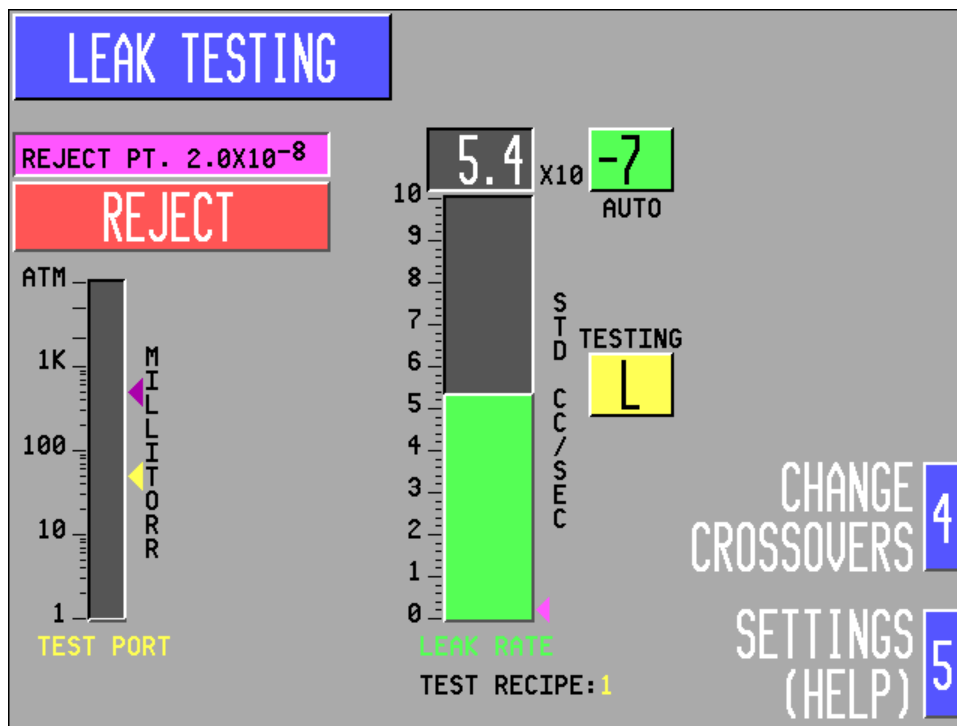

Figure G-3 MS-50 Dual Port: Test Port Indicator Display

During testing, either an L or an R (for the *left* and *right* ports, respectively) appears to the right of the LEAK RATE bar graph (*see fig. G-3*) to indicate which test port is currently being used. In between tests, this feature allows operators to determine which port was most recently used.

During a test, the word **TESTING** appears above the port indicator. When the test is terminated, the word **TESTED** appears below the port indicator.

When a test cycle is initiated, testing proceeds as in the standard MS-50 (*see manual, section 3.2*). When the test is complete, the cycle can be terminated by *momentarily* pressing the VENT switch (or either START switch). This closes all test valves (and the appropriate port valve) and places the dual unit into standby (Ready To Test) mode.

When a new test cycle is started, the opposite port vent valve opens, venting the port section, and remains open for a pre-selected vent duration (*set by the user; see manual, section 3.4*).

NOTE:

If the vent duration is set to the maximum of 999.9 seconds, the vent valve will remain open indefinitely. If desired, this can also be accomplished by decreasing the vent duration time below 0.1 seconds; the timer automatically wraps around to 999.9 seconds.

By pressing and continuing to hold down the VENT switch for a predetermined vent open delay (*set by the user; see manual, section 3.4.12*), both test ports, as well as the valve block, will be vented. Because the valve block will initially be at atmosphere, the subsequent test cycle will take longer to complete.

MS-50 Dual Port Tuning and Calibration

Tuning/Cal Check

When the MS-50 Dual performs an Auto Tune or a Cal Check (using the internal calibrator) both port valves are closed and both port vent valves will open for a user-specified vent duration. During tuning and calibration, operators may safely attach or remove fixtures from both test ports, or perform any external test set-up, since both the left and right test ports are completely isolated from the Tuning/Calibration process.

Because the port valves remain closed, neither the L or R port indicators appear on the CRT screen while the unit is tuning to an internal calibrator. The port indicator will not appear again until a test cycle is initiated on one of the ports.

Using An External Calibrator

When tuning the MS-50 Dual to an external calibrator (*see manual, section 3.4.25*), the calibrator *must* be attached to the *left* test port. An L appears next to the LEAK RATE bar graph as a reminder to the operator.

After the external calibrator has been installed into the left test port (with the calibrator valve open), press the TUNE key on the user panel (*fig. G-2*). The tuning cycle proceeds as usual. During the tuning cycle, the right test port is isolated from the vacuum system, allowing set-up to occur on that side.

If a Cal Check is performed using an external calibrator, the left test port must first be plugged using a test port blank. After the port has been plugged, the CAL CHECK switch on the user panel may be pressed. The operator then follows the on-screen prompts to install the appropriate calibrator into the left test port (with the calibrator valve open). Cal Check proceeds as usual (*see manual, section 3.3.2*). During Cal Check, the right port is isolated from the vacuum system, so set-up may occur on that side.

Sleep Mode

When the MS-50 Dual is placed into Sleep Mode (*see manual, page 3-9*), both the left and right test ports are pumped down. The port valves are then closed, trapping the vacuum in both test ports. Before placing the MS-50 Dual into Sleep Mode, make sure that any test fixtures are closed or ported off, or that the fixtures are removed and test port plugs are installed. The MS-50 cannot be placed into sleep mode from Leak Testing mode. Sleep Mode can only be entered when the leak detector is in standby.

Nitrogen Purging

It is highly recommended that the MS-50 Dual be connected to facilities dry nitrogen (*see manual, section 1.2*). In dual port units, internal attachments to all three vent valves and the fore pump have already been made in the factory (*see figure G-4*). Follow the steps on page g-vi to connect the MS-50 Dual to facilities dry nitrogen.

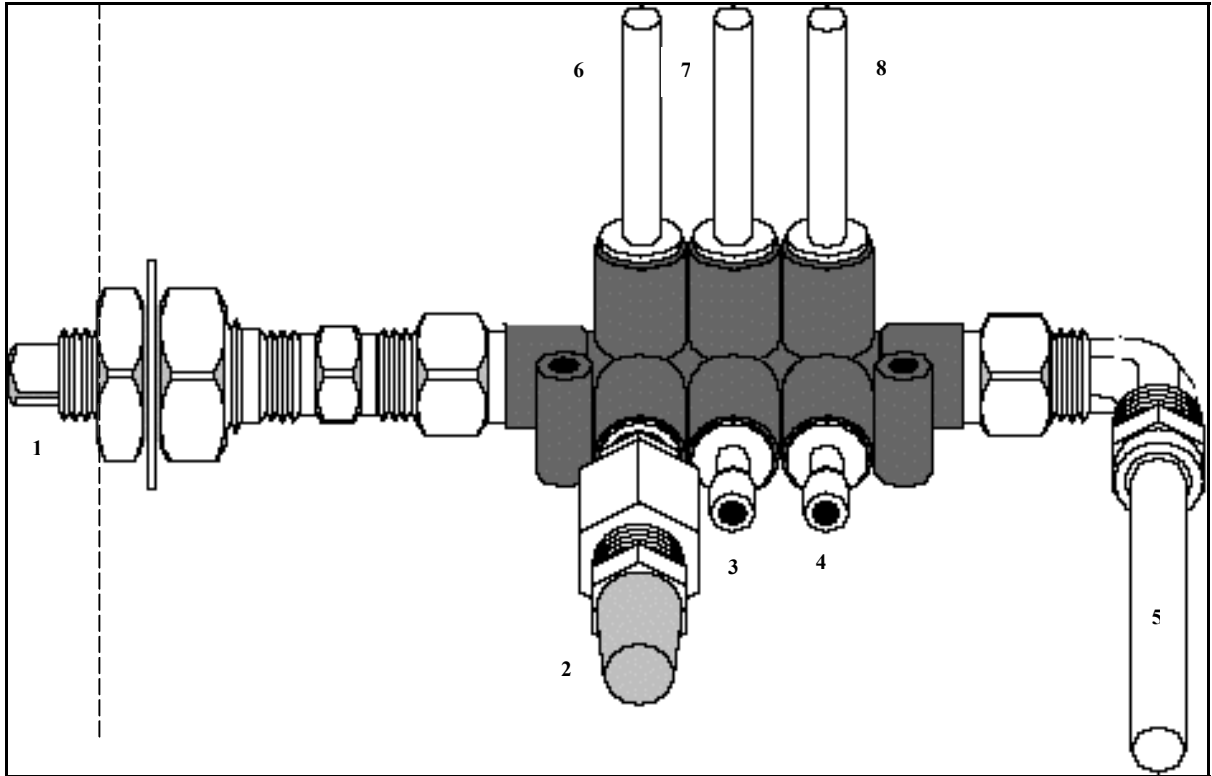
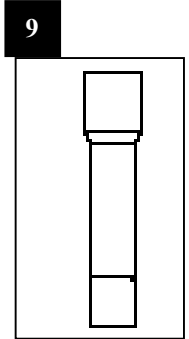

Figure G-4 MS-50 Dual Port N2 Purge System

- | | |
|--|--------------------------|
| 1. N2 Purge Port
(Connect to Facilities Dry Nitrogen) | 5. To Fore Pump |
| 2 Vent Filter (Sintered Metal) | 6 To Test Port Block (1) |
| 3 Blank Plug | 7 To Test Port Block (2) |
| 4 Blank Plug | 8 To Valve Block |



To connect the MS-50 Dual to facilities dry nitrogen:

- 1 Remove the sintered metal vent filter (2) and insert a blank plug (see inset, 9) in its place.
- 2 Remove the square blank plug (1) from the nitrogen purge port on the rear of the unit.
- 3 Connect to facilities dry nitrogen to purge port using 3/8" O.D. plastic tubing.

Service Mode

Other than the presence of some additional controls (for the operation of dual port valves and vent valves), Service Mode in the MS-50 Dual functions identically to that of the standard MS-50 unit.

WARNING!

Service Mode is a totally unprotected mode, and should be used only by service personnel or by very experienced users!

In Service Mode, as in Test Mode, the left and right port valves are operated using the AUX1 and AUX2 valve buttons (see G-2). While in Service Mode, the state of the valve (open or closed) is displayed on the CRT vacuum system schematic (fig. G-1). A green valve symbol indicates that the valve is open, and a red valve symbol indicates that the valve is closed.

Because there is no indication of the pressure in the individual test port areas (left and right), it is recommended that the test port valves not be opened unless all other valves are closed.

While in Service Mode, the operator can toggle individual port and vent valves open or closed by pressing the auxiliary VALVE keys (AUX 1 - 4), as follows (see figure G-2 for auxiliary key locations):

MS-50 Dual Port Auxiliary Key Functions:

- AUX 1:** Left Port -Valve Open/Close
- AUX 2:** Right Port -Valve Open/Close
- AUX 3:** Left Vent -Valve Open/Close
- AUX 4:** Right Vent -Valve Open/Close

MS-50 Dual Port Module Assembly/Parts List

The MS-50 Dual Port Module Assembly is shown in figure G-5. The list on the following page corresponds to the items identified in figure G-5 and should be used as reference when ordering spare parts.

Parts List For MS-50 Dual Port Module Assembly

1	0139-203-00	Left/Right Test Port
2	Commercial	Screw, Socket Head, #10-32 x 2 1/4"
3	Commercial	Washer, Split Lock, #10
4	Commercial	Washer, Flat, #10
5	0139-272-00	Left Side Test Port Block
6	0011-121-00	O-Ring, 1 1/16" x 3/32"
7	0136-481-00	Ring Clamp
8	Commercial	Screw, Socket Head, #10-32 x 1/2"
9	Commercial	Washer, Split Lock, #10
10	0139-273-00	Manifold
11	0011-024-00	O-Ring, 1 1/8" x 1/16"
12	0136-480-01	Valve Adapter, 1/2 NPT
13	0136-495-01	Valve Repair Kit
14	0139-105-00	Port Valve, 115VAC
15	0137-120-02	Vent Valve, 24VDC
16	0139-272-01	Right Side Test Port Block
17	0011-216-00	O-Ring, 1 1/8" x 1/8"
18	3140-003-00	Washer, Q.C.
19	1621-229-04	Nut, Q.C.
20	0126-284-00	Blank Plug, Q.C.
21	1890-179-00	Inlet Filter

Figure G-5: MS-50 Dual Port Module Assembly

